



















48V  
Li-ion

	Airbag		Gas-generator		Gurtstraffer		SRS-Steuergerät		Aktives Fußgänger-schutzsystem
	Automatischer Überrollschutz		Gasdruckfeder/vorgespannte Feder		Hochfester Stahl		Zone, die besondere Aufmerksamkeit erfordert		
	Niederspannungsbatterie		Ultra-kondensator, Niederspannung		Kraftstoff-tank		Gastank		Sicherheitsventil
	Hochvolt-batteriepack		Hochvolt-kabel/-teil		Notfall-trennstelle		Sicherung/Abschalten der Hochspannung		Ultra-kondensator, Hochspannung

# 1. Identifizierung/Erkennen des Fahrzeugtyps

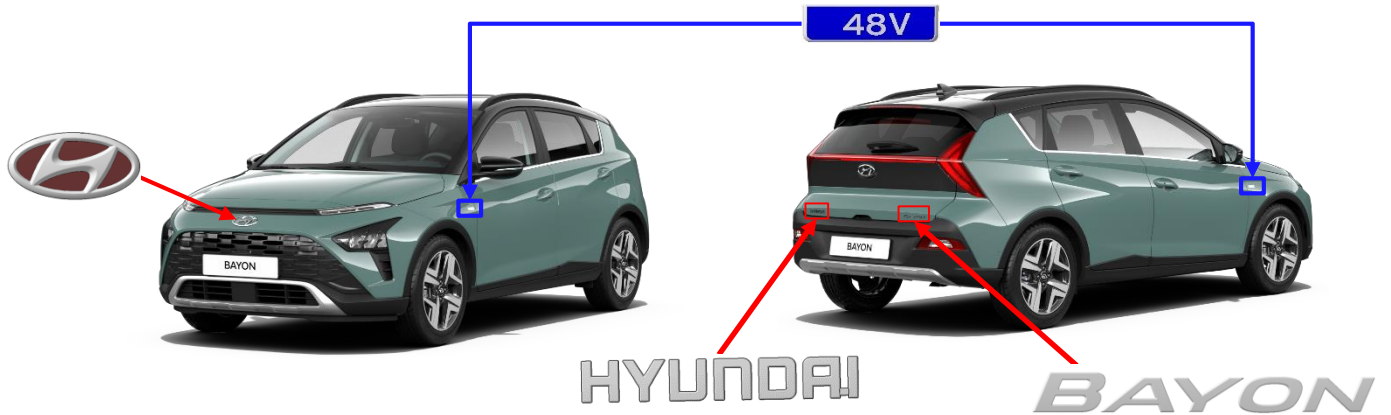

## 2. Fahrzeug gegen Wegrollen sichern/stabilisieren/anheben

### ■ Sichern gegen Wegrollen



Handbremse so weit wie möglich anziehen

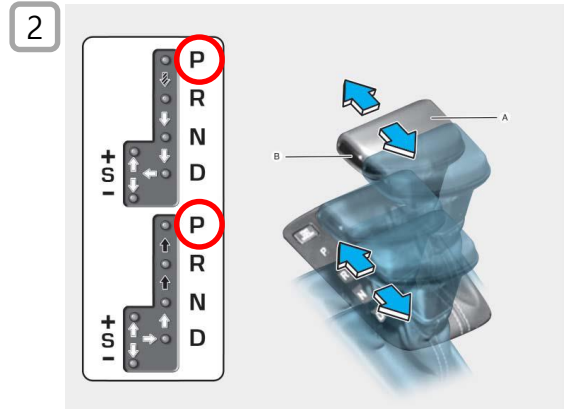

Bei Fahrzeugen mit Automatikgetriebe:  
Wählhebel in Position P bringen

### ■ Hebepunkte am Fahrzeugunterboden: ●

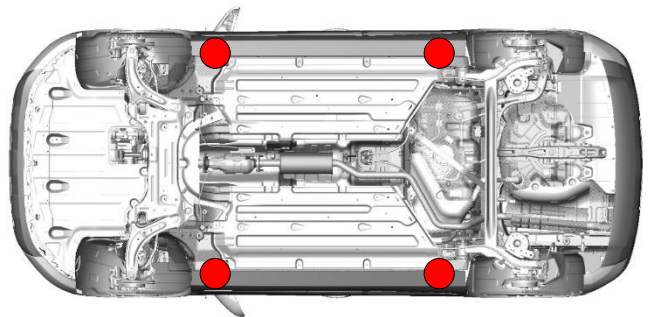
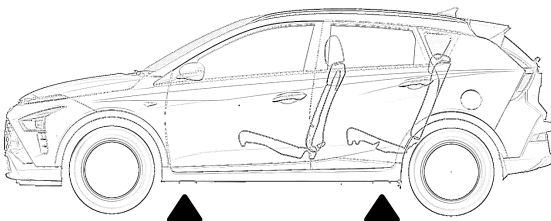

	ID Nr.	Versionsnr.	Versionsdatum	Seite
	NLH-BC3-RSM-01-202104	01	04/2021	2 von 4

### 3. Ausschalten direkter Gefahren / Sicherheitsmaßnahmen

#### ■ Zugang zur 12V-Batterie

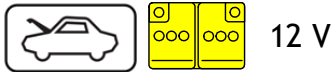

Ziehen Sie den Entriegelungshebel an, um die Motorhaube zu entriegeln. Die Haube sollte leicht aufspringen.

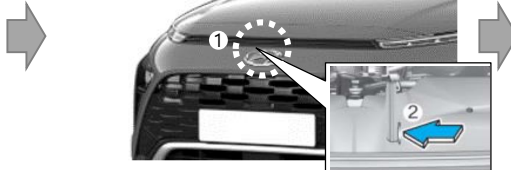

Heben Sie die Haube leicht an, drücken Sie den Fanghaken innen in der Mitte (1) nach oben und öffnen Sie die Haube (2).

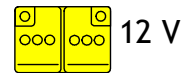

#### ■ Deaktivierung

① Zündung ausschalten

② Minuspol (-) abklemmen

③ Pluspol (+) abklemmen

#### ■ Zugang zur 48V-Batterie

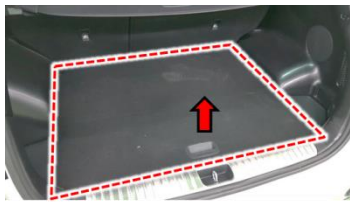
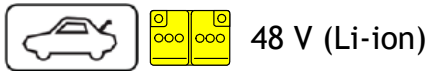

Öffnen Sie den Kofferraum und entfernen Sie die Abdeckung.



Entfernen Sie anschließend die Schaumstoffeinlage.



Sie finden dort den Lüftungskanal (Ein-/Auslass) und das 48V-Batteriesystem.

#### ■ Deaktivierung

- ① Schalten Sie den Motor aus und warten dann ca. 10 Minuten.
- ② Klemmen Sie das Minuskabel (-) von der 12V-Batterie in der Haube ab.
- ③ Klemmen Sie das 12V-Pluskabel (+) vom 48V-Batteriepack ab.
- ④ Klemmen Sie erst das 48V-Minuskabel (-), dann das Pluskabel (+) ab.
- ⑤ Klemmen Sie das BMS EXTN Kabel ab.

### 4. Zugang zu den Insassen

#### ■ Glas

1 : Verbundglas  
2-5 : Gehärtetes Glas



#### ■ Karosserie

Gehärteter Stahl

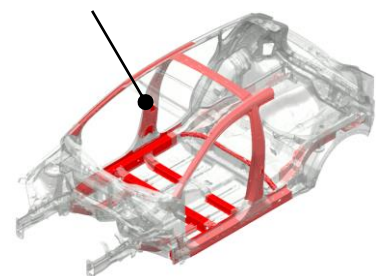

	ID Nr.	Versionsnr.	Versionsdatum	Seite
	NLH-BC3-RSM-01-202104	01	04/2021	3 von 4

## 5. Gespeicherte Energie / Flüssigkeiten / Gase / Feststoffe

### ■ Kraftstofftank

40ℓ

### ■ Batterie



12 V



48 V (Li-ion)

## 6. Im Brandfall

### ■ Gasdruckfeder

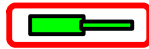

· Durch Hitzeentwicklung in den Gasdruckfedern besteht ein Risiko, dass die Heckklappe unkontrolliert hochschnellt.

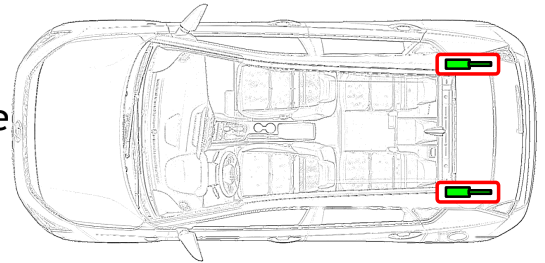

## 7. Falls das Fahrzeug unter Wasser gerät

Berühren Sie keine der 48V-Komponenten oder –Kabel, da Gefahr eines Stromschlags besteht. Führen Sie Arbeiten am Fahrzeug erst durch, nachdem es aus dem Wasser gezogen wurde.

## 8. Abschleppen / Transport / Lagerung

### ■ OK

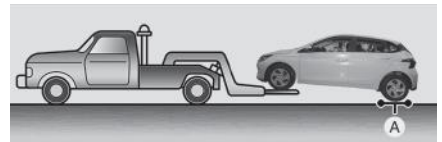
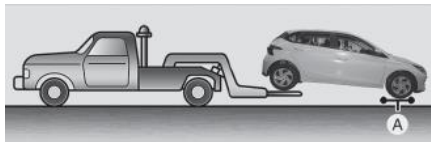
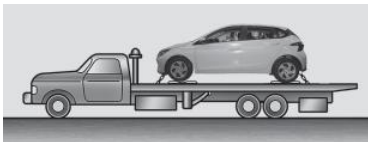

[A] : Nachläufer

### ■ NICHT OK



	ID Nr.	Versionsnr.	Versionsdatum	Page
	NLH-BC3-RSM-01-202104	01	04/2021	4 von 4