



# HYUNDAI

## Rettungsdatenblätter für Rettungskräfte

### **Hinweis:**

Diese Rettungsdatenblätter wurden ausschließlich für Rettungskräfte erstellt, die über eine spezielle Ausbildung auf dem Gebiet der technischen Hilfeleistung nach Verkehrsunfällen und der damit verbundenen Tätigkeiten verfügen. Ferner enthalten die Rettungsdatenblätter ausschließlich Informationen über Fahrzeuge, die zum Verkauf in Deutschland bestimmt sind.

Spezifikationen und Sonderausstattungen der Hyundai Fahrzeuge sowie das Fahrzeugangebot unterliegen stetig etwaigen Änderungen. Daher behält sich Hyundai inhaltliche Anpassungen bzw. Änderungen an den Rettungsdatenblättern jederzeit ausdrücklich vor.

Die in diesem Leitfaden enthaltenen Informationen sind nicht für Endkunden und ebenfalls nicht für Werkstätten und Händler bestimmt. Endkunden können den Bordbüchern ihres jeweiligen Fahrzeuges detaillierte Informationen zu den Funktionen ihres Fahrzeuges sowie wichtige Sicherheitshinweise zur Fahrzeug- und Insassensicherheit entnehmen. Werkstätten und Händler erhalten Reparaturinformationen über die ihnen bekannten Bezugsquellen.

## A

|                    |            |         |
|--------------------|------------|---------|
| • Accent (3-Türer) | LC         | ab 2000 |
| • Accent (5-Türer) | LC         | ab 2000 |
| • Accent (3-Türer) | MC         | ab 2006 |
| • Accent (4-Türer) | MC         | ab 2006 |
| • Atos             | MX/MSL/MXI | ab 1998 |

## C

|         |    |         |
|---------|----|---------|
| • Coupe | GK | ab 2002 |
| • Coupe | GK | ab 2006 |

## E

|                     |    |         |
|---------------------|----|---------|
| • Elantra (4-Türer) | XD | ab 2000 |
| • Elantra (5-Türer) | XD | ab 2000 |

## G

|                  |    |         |
|------------------|----|---------|
| • Genesis Coupe  | BK | ab 2011 |
| • Genesis        | DH | ab 2014 |
| • Getz (3-Türer) | TB | ab 2002 |
| • Getz (5-Türer) | TB | ab 2002 |
| • Grandeur       | TG | ab 2005 |

## H

|                       |    |         |
|-----------------------|----|---------|
| • H-1                 | H1 | ab 1998 |
| • H-1                 | H1 | ab 2008 |
| • H-350 (Cargo)       | EU | ab 2015 |
| • H-350 (Fahrgestell) | EU | ab 2015 |
| • H-350 (Bus)         | EU | ab 2016 |

## I

|                 |        |         |
|-----------------|--------|---------|
| • i10           | PA     | ab 2008 |
| • i10           | PA     | ab 2011 |
| • i10           | IA     | ab 2014 |
| • i10           | AC3    | ab 2019 |
| • i20 (3-Türer) | PB     | ab 2008 |
| • i20 Coupe     | GB     | ab 2015 |
| • i20 (5-Türer) | PB     | ab 2008 |
| • i20 (5-Türer) | GB     | ab 2014 |
| • i30           | FD/FDH | ab 2008 |
| • i30           | GDH    | ab 2012 |
| • i30           | PDE    | ab 2017 |
| • i30 Coupe     | GDH    | ab 2013 |
| • i30 Fastback  | PDE    | ab 2017 |
| • i30cw         | FD/FDH | ab 2008 |
| • i30cw         | GDH    | ab 2012 |
| • i30cw         | PDE    | ab 2017 |
| • i40 (4-Türer) | VF     | ab 2012 |
| • i40cw         | VF     | ab 2011 |

**In den Rettungsdatenblättern ist immer die maximal mögliche Ausstattung des Fahrzeugs angegeben.**

## I

|                        |         |         |
|------------------------|---------|---------|
| • ix20 (5-Türer)       | JC      | ab 2010 |
| • ix35                 | EL      | ab 2010 |
| • ix35 FCEV            | LM      | ab 2013 |
| • ix55                 | EN      | ab 2009 |
| • Ioniq Hybrid         | AE HEV  | ab 2016 |
| • Ioniq Hybrid         | AE HEV  | ab 2017 |
| • Ioniq Elektro        | AE EV   | ab 2016 |
| • Ioniq Elektro        | AE EV   | ab 2019 |
| • Ioniq Plug-in Hybrid | AE PHEV | ab 2017 |

## K

|                |        |         |
|----------------|--------|---------|
| • Kona         | OS     | ab 2017 |
| • Kona Elektro | OS EV  | ab 2018 |
| • Kona Hybrid  | OS HEV | ab 2019 |

## M

|          |        |         |
|----------|--------|---------|
| • Matrix | FC/FCT | ab 2002 |
|----------|--------|---------|

## N

|             |    |         |
|-------------|----|---------|
| • Nexo FCEV | FE | ab 2018 |
|-------------|----|---------|

## S

|                    |       |         |
|--------------------|-------|---------|
| • Santa Fe         | SM    | ab 2000 |
| • Santa Fe         | CM    | ab 2006 |
| • Santa Fe         | TM    | ab 2018 |
| • (Grand) Santa Fe | DM/NC | ab 2012 |
| • Sonata           | EF    | ab 1999 |
| • Sonata           | EF    | ab 2001 |
| • Sonata           | NF    | ab 2005 |

## T

|            |     |         |
|------------|-----|---------|
| • Terracan | HP  | ab 2001 |
| • Trajet   | FO  | ab 2000 |
| • Tucson   | JM  | ab 2004 |
| • Tucson   | TLE | ab 2015 |
| • Tucson   | TLE | ab 2019 |

## V

|            |    |         |
|------------|----|---------|
| • Veloster | FS | ab 2011 |
|------------|----|---------|







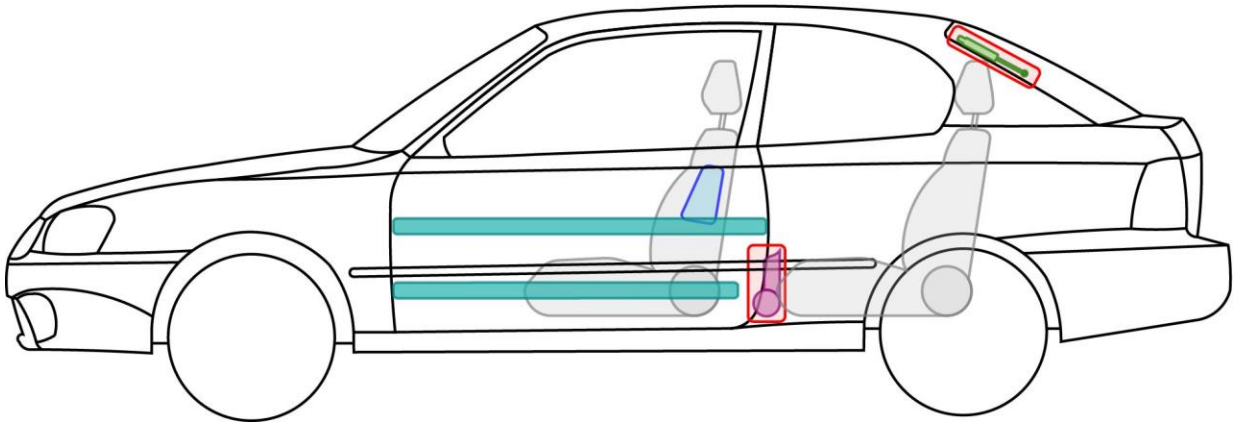
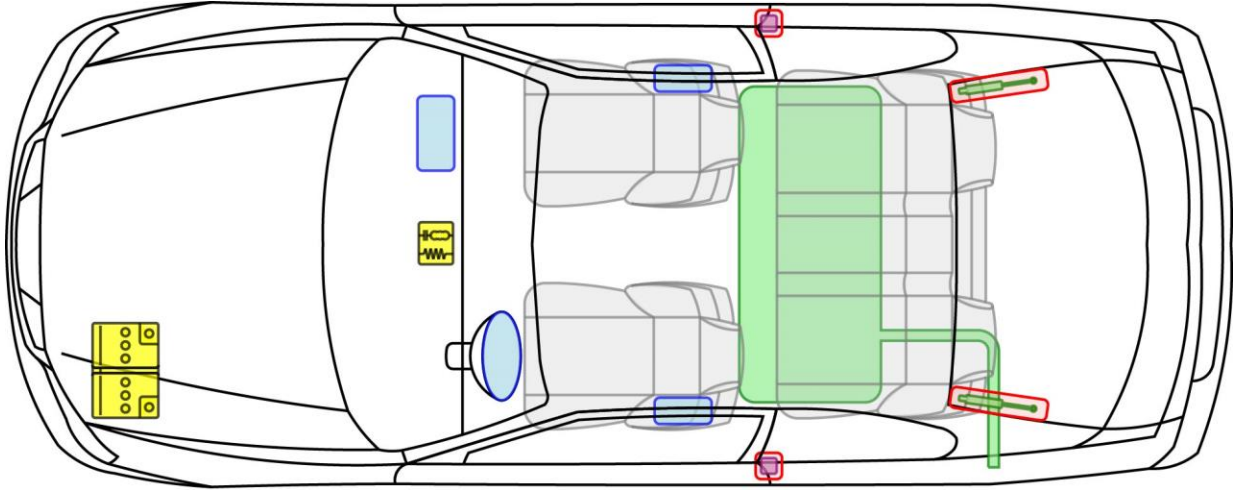

## X

|      |    |         |
|------|----|---------|
| • XG | XG | ab 1999 |
|------|----|---------|

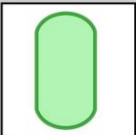
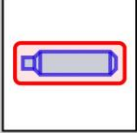
**In den Rettungsdatenblättern ist immer die maximal mögliche Ausstattung des Fahrzeugs angegeben.**

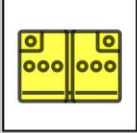

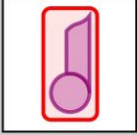
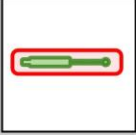





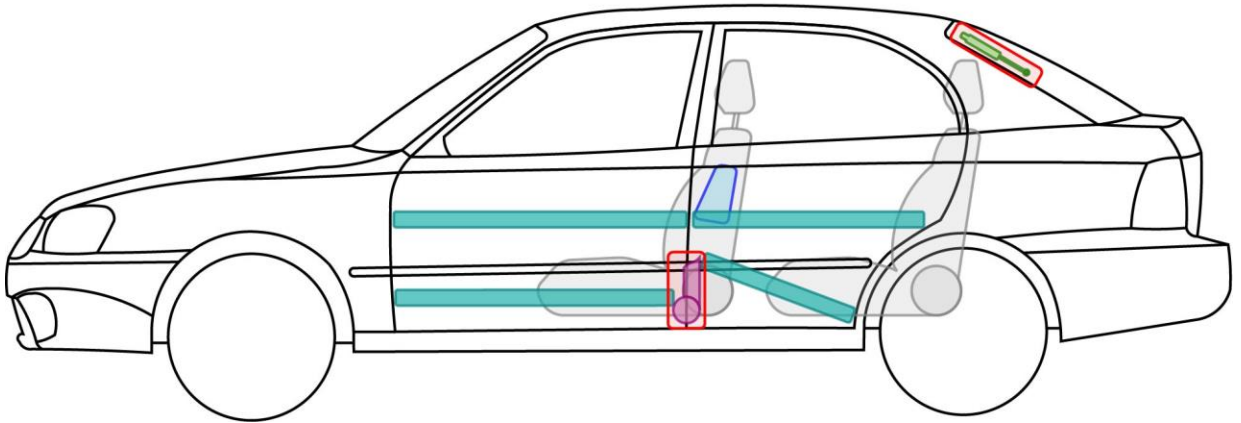
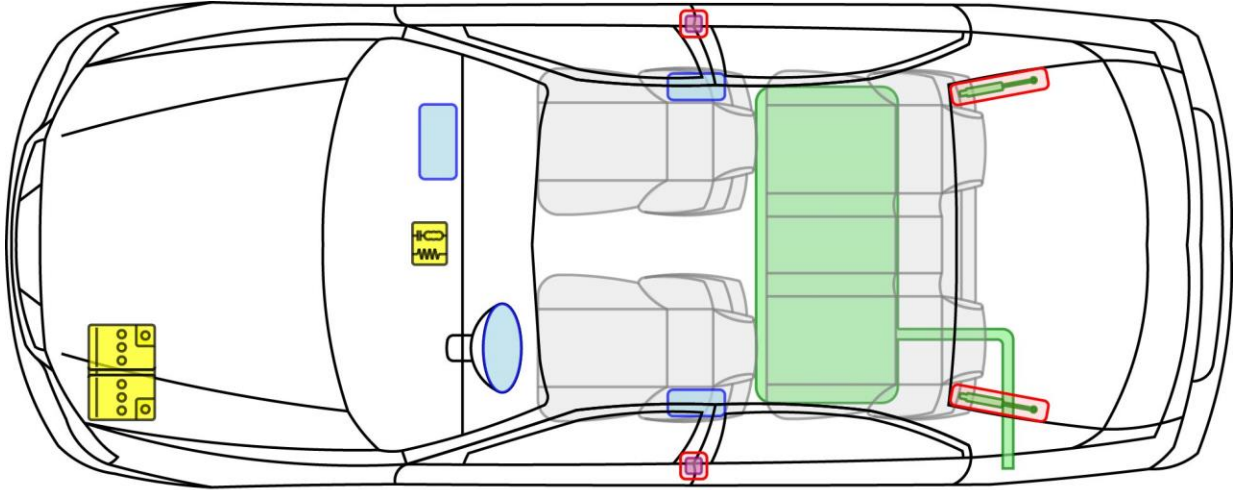

**Legende**

|   |                   |   |                            |   |                     |   |                            |
|---|-------------------|---|----------------------------|---|---------------------|---|----------------------------|
|  | Airbag            |  | Karosserie-<br>verstärkung |  | Steuergerät         |  | Gastank                    |
|  | Gas-<br>generator |  | Überroll-<br>schutz        |  | 12 V<br>Batterie    |  | Sicherheits-<br>ventil     |
|  | Gurt-<br>straffer |  | Gasdruck-<br>dämpfer       |  | Kraftstoff-<br>tank |  | Fußgänger-<br>schutzsystem |

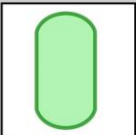
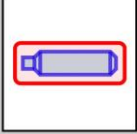
**Accent**

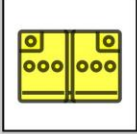

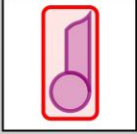
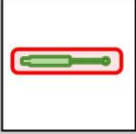





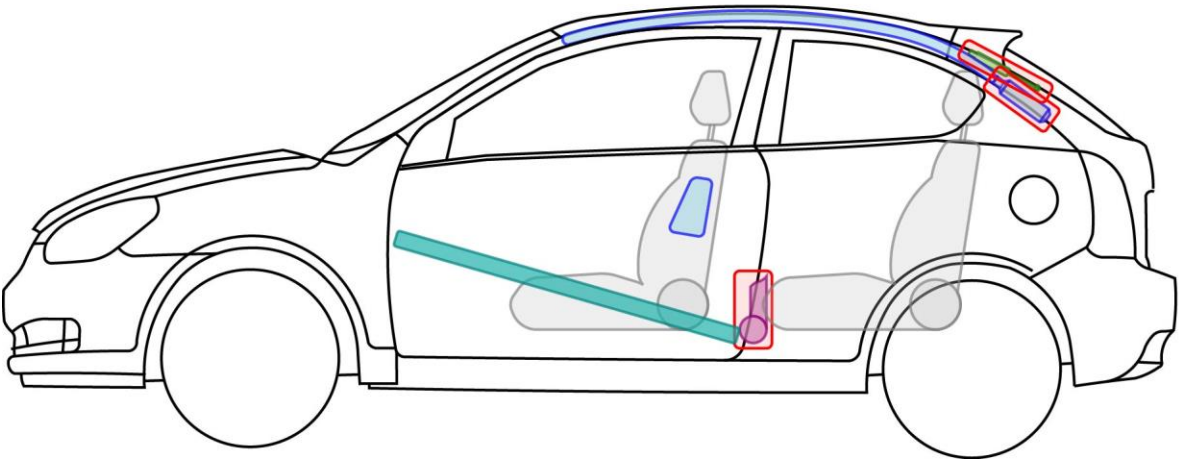
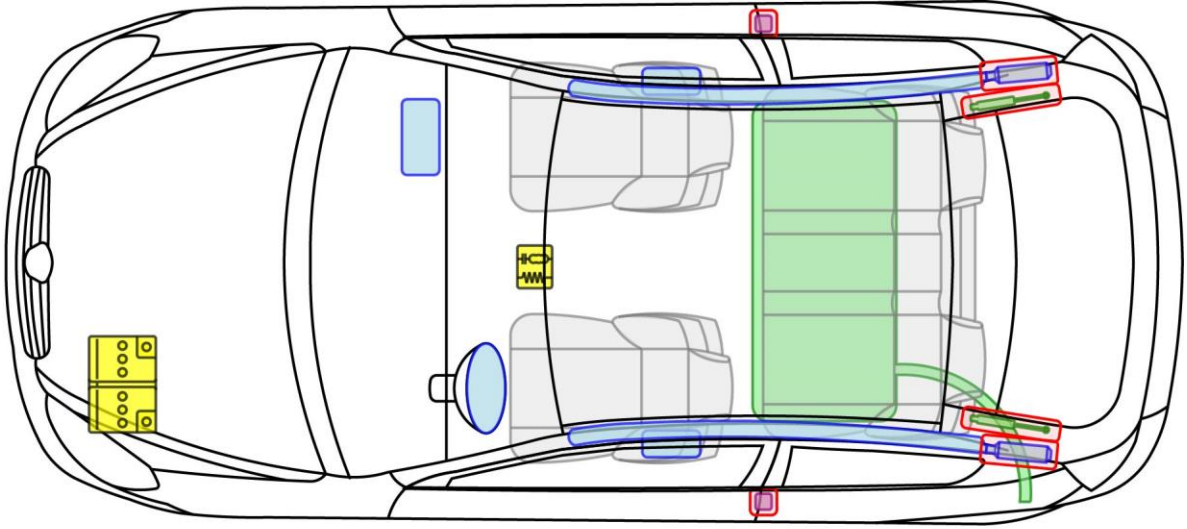

**Legende**

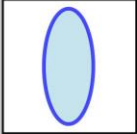
|   |                   |   |                            |   |                     |   |                            |
|---|-------------------|---|----------------------------|---|---------------------|---|----------------------------|
|  | Airbag            |  | Karosserie-<br>verstärkung |  | Steuergerät         |  | Gastank                    |
|  | Gas-<br>generator |  | Überroll-<br>schutz        |  | 12 V<br>Batterie    |  | Sicherheits-<br>ventil     |
|  | Gurt-<br>straffer |  | Gasdruck-<br>dämpfer       |  | Kraftstoff-<br>tank |  | Fußgänger-<br>schutzsystem |

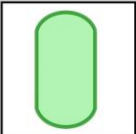
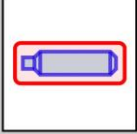
**Accent**

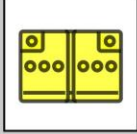

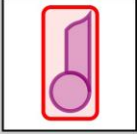
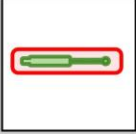





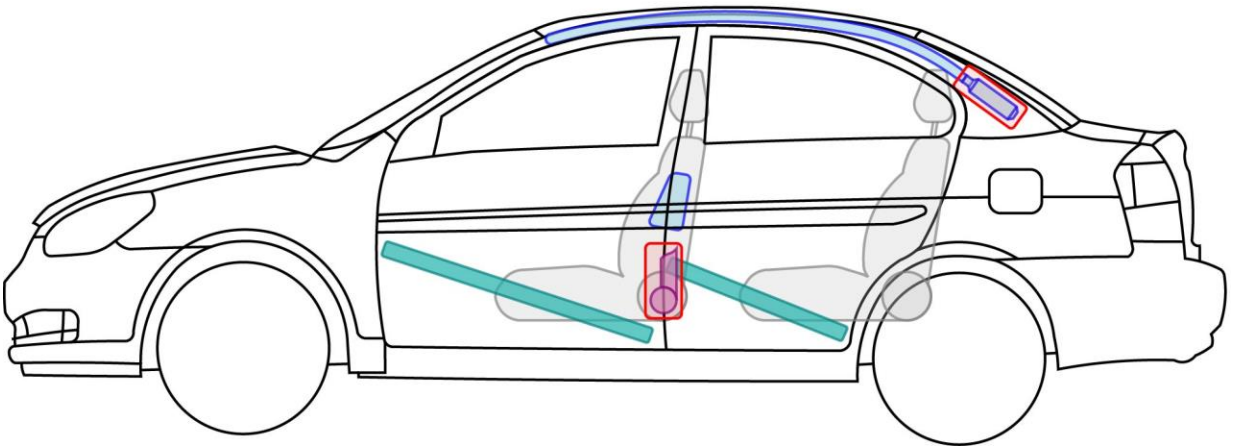
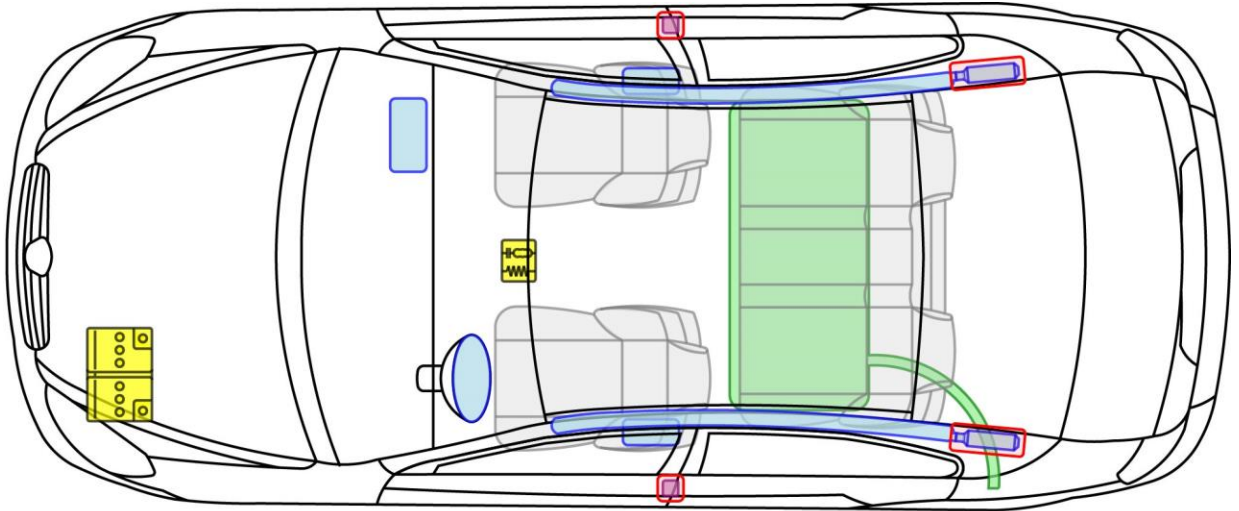

**Legende**

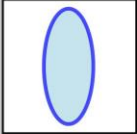
|   |                   |   |                            |   |                     |   |                            |
|---|-------------------|---|----------------------------|---|---------------------|---|----------------------------|
|  | Airbag            |  | Karosserie-<br>verstärkung |  | Steuergerät         |  | Gastank                    |
|  | Gas-<br>generator |  | Überroll-<br>schutz        |  | 12 V<br>Batterie    |  | Sicherheits-<br>ventil     |
|  | Gurt-<br>straffer |  | Gasdruck-<br>dämpfer       |  | Kraftstoff-<br>tank |  | Fußgänger-<br>schutzsystem |

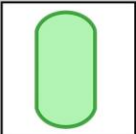
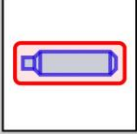
**Accent**

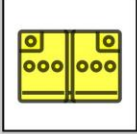

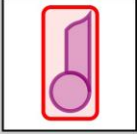
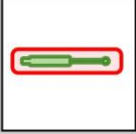





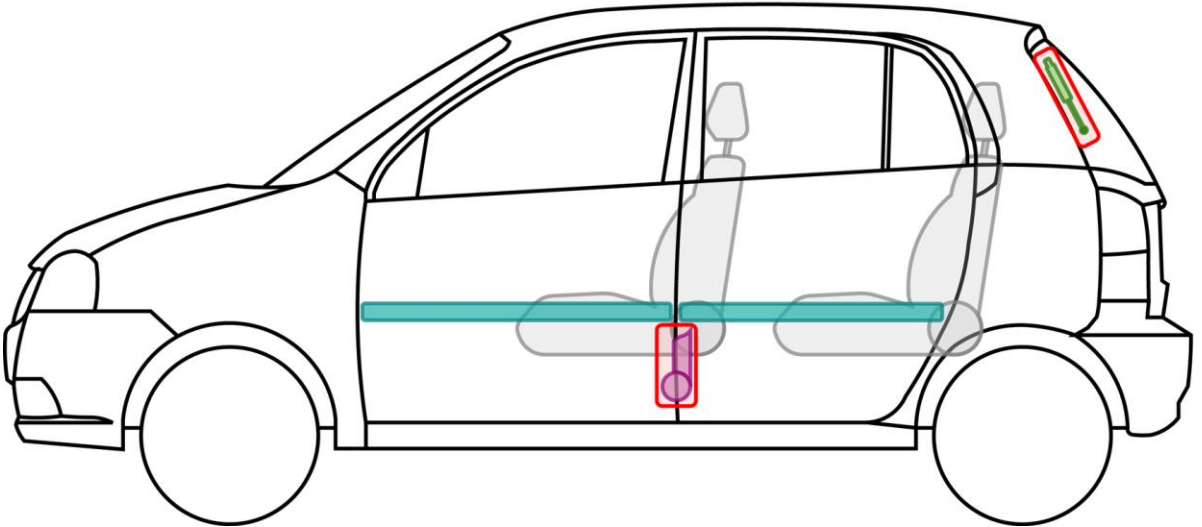
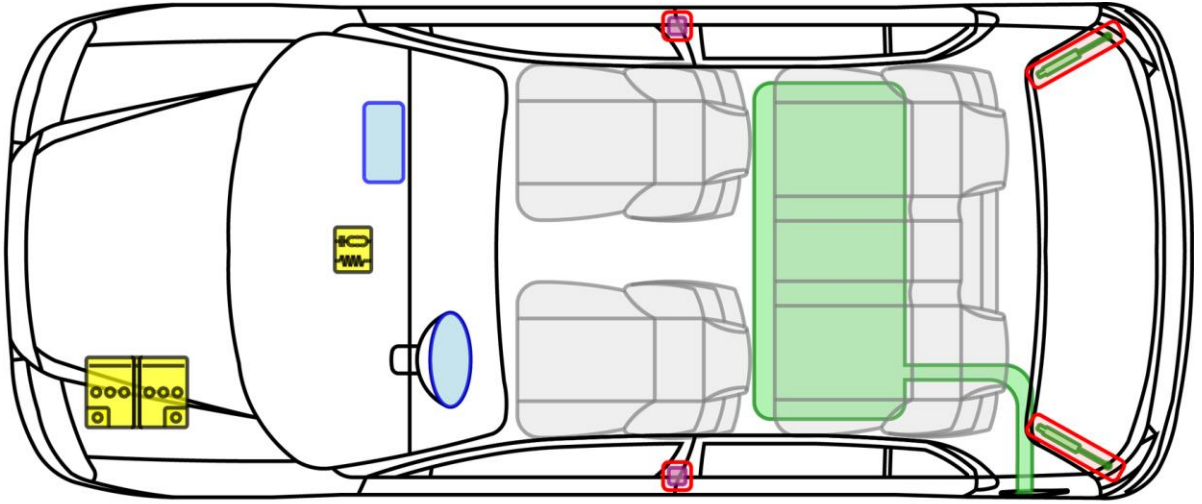

**Legende**

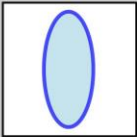
|   |                   |   |                            |   |                     |   |                            |
|---|-------------------|---|----------------------------|---|---------------------|---|----------------------------|
|  | Airbag            |  | Karosserie-<br>verstärkung |  | Steuergerät         |  | Gastank                    |
|  | Gas-<br>generator |  | Überroll-<br>schutz        |  | 12 V<br>Batterie    |  | Sicherheits-<br>ventil     |
|  | Gurt-<br>straffer |  | Gasdruck-<br>dämpfer       |  | Kraftstoff-<br>tank |  | Fußgänger-<br>schutzsystem |

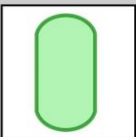
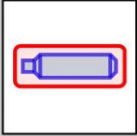
**Accent**

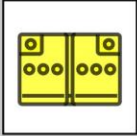

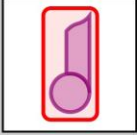
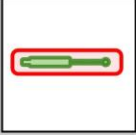
**Legende**







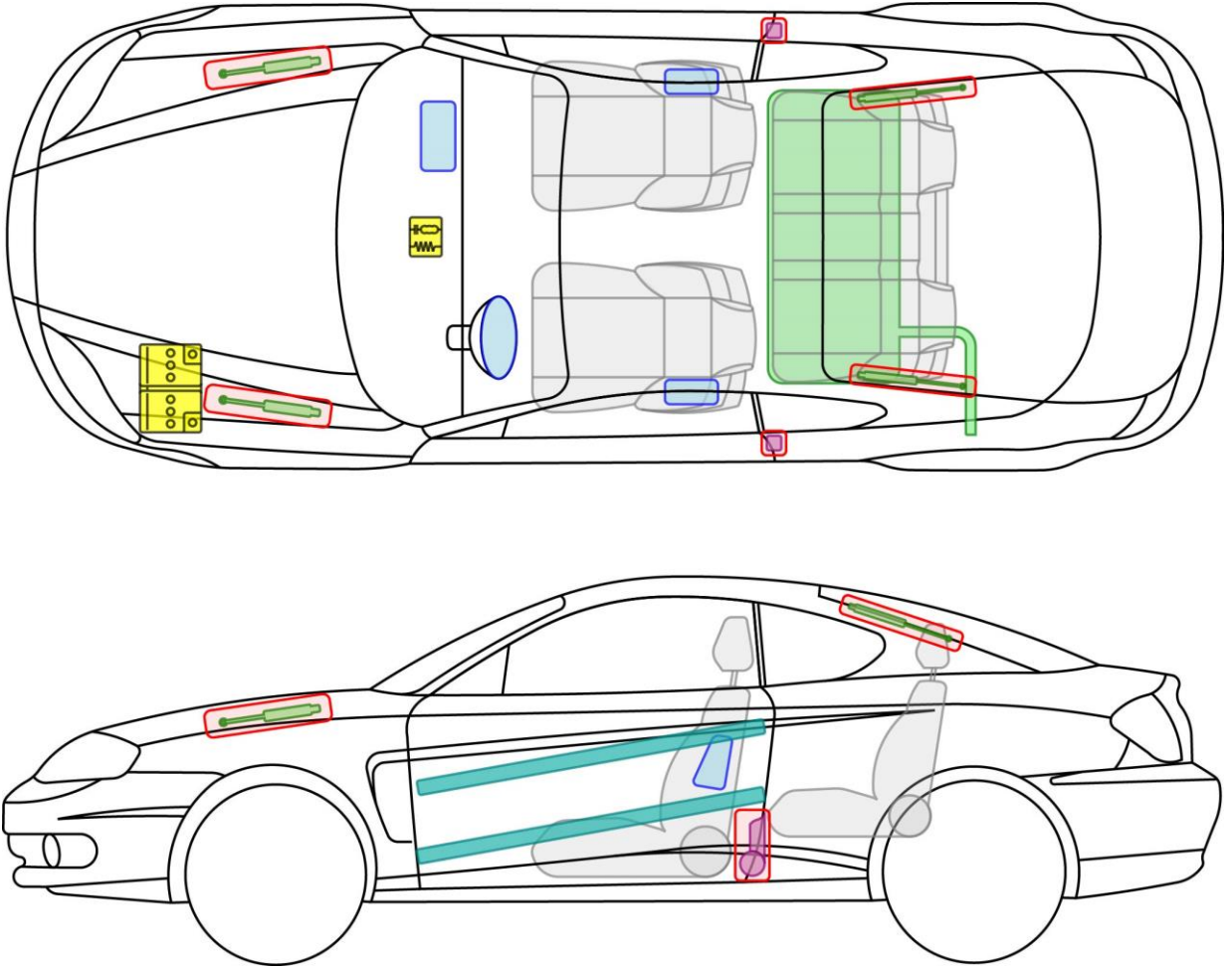

|   |                   |   |                            |   |                     |   |                            |
|---|-------------------|---|----------------------------|---|---------------------|---|----------------------------|
|  | Airbag            |  | Karosserie-<br>verstärkung |  | Steuergerät         |  | Gastank                    |
|  | Gas-<br>generator |  | Überroll-<br>schutz        |  | 12 V<br>Batterie    |  | Sicherheits-<br>ventil     |
|  | Gurt-<br>straffer |  | Gasdruck-<br>dämpfer       |  | Kraftstoff-<br>tank |  | Fußgänger-<br>schutzsystem |

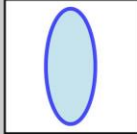
**Atos**

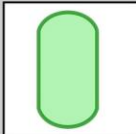
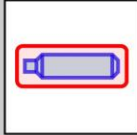

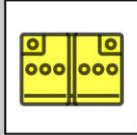

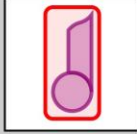
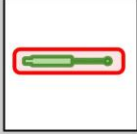





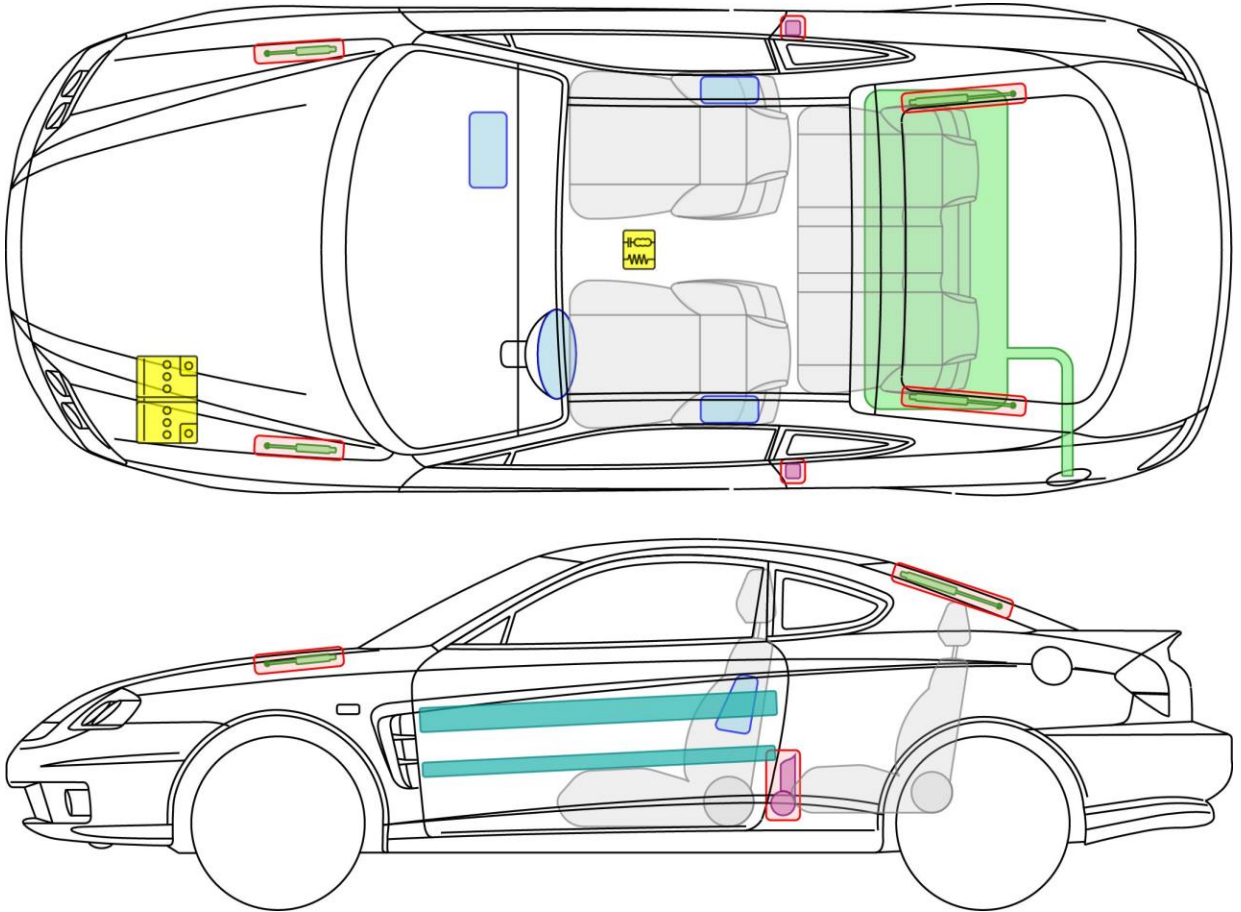



**Legende**

|   |               |   |                        |   |                 |   |                        |
|---|---------------|---|------------------------|---|-----------------|---|------------------------|
|  | Airbag        |  | Karosserie-verstärkung |  | Steuergerät     |  | Gastank                |
|  | Gas-generator |  | Überroll-schutz        |  | 12 V Batterie   |  | Sicherheits-ventil     |
|  | Gurt-straffer |  | Gasdruck-dämpfer       |  | Kraftstoff-tank |  | Fußgänger-schutzsystem |

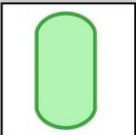
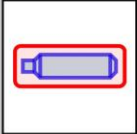
**Coupe**



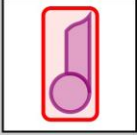
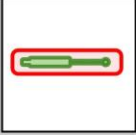





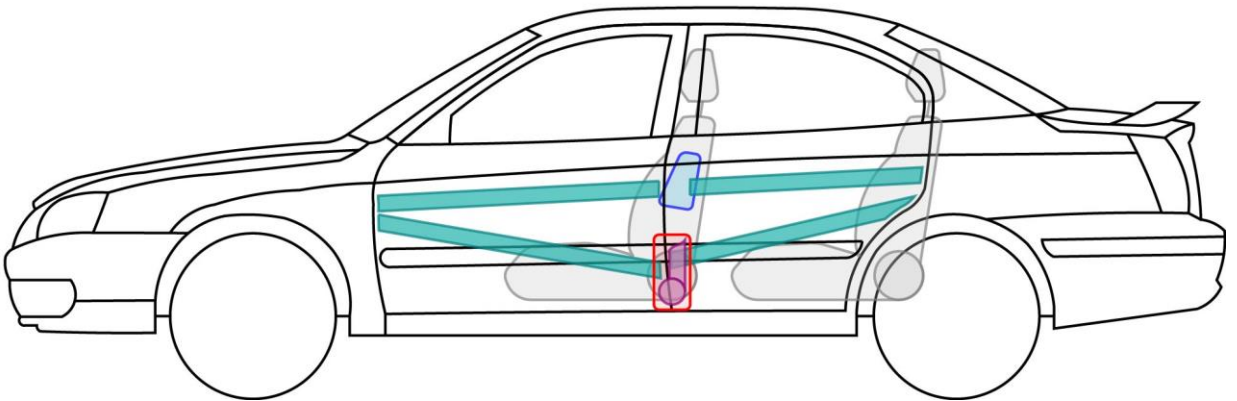
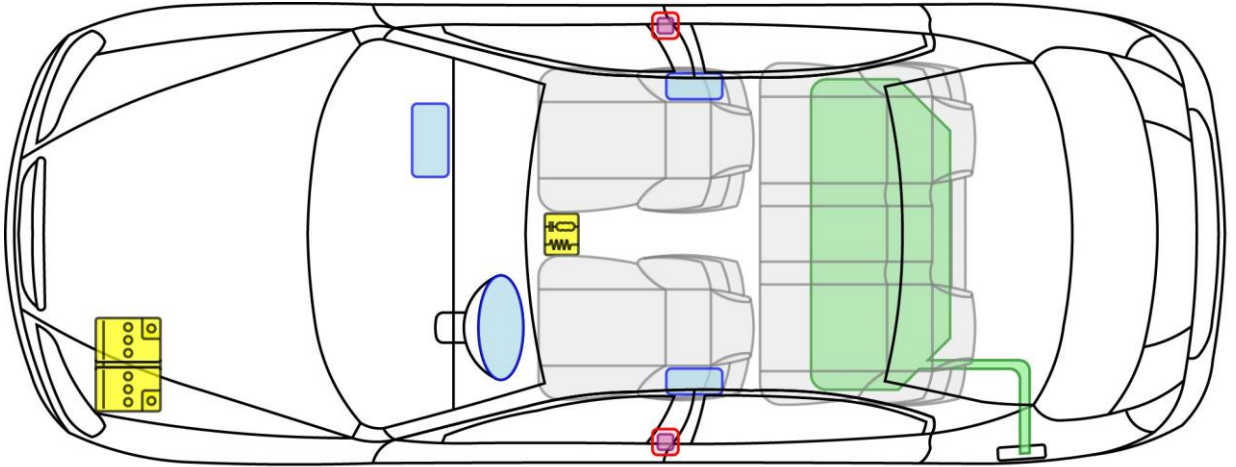

**Legende**

|   |                   |   |                            |   |                     |   |                            |
|---|-------------------|---|----------------------------|---|---------------------|---|----------------------------|
|  | Airbag            |  | Karosserie-<br>verstärkung |  | Steuergerät         |  | Gastank                    |
|  | Gas-<br>generator |  | Überroll-<br>schutz        |  | 12 V<br>Batterie    |  | Sicherheits-<br>ventil     |
|  | Gurt-<br>straffer |  | Gasdruck-<br>dämpfer       |  | Kraftstoff-<br>tank |  | Fußgänger-<br>schutzsystem |

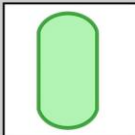
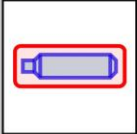
**Coupe**

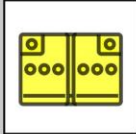

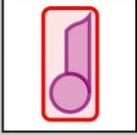
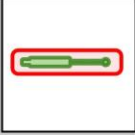





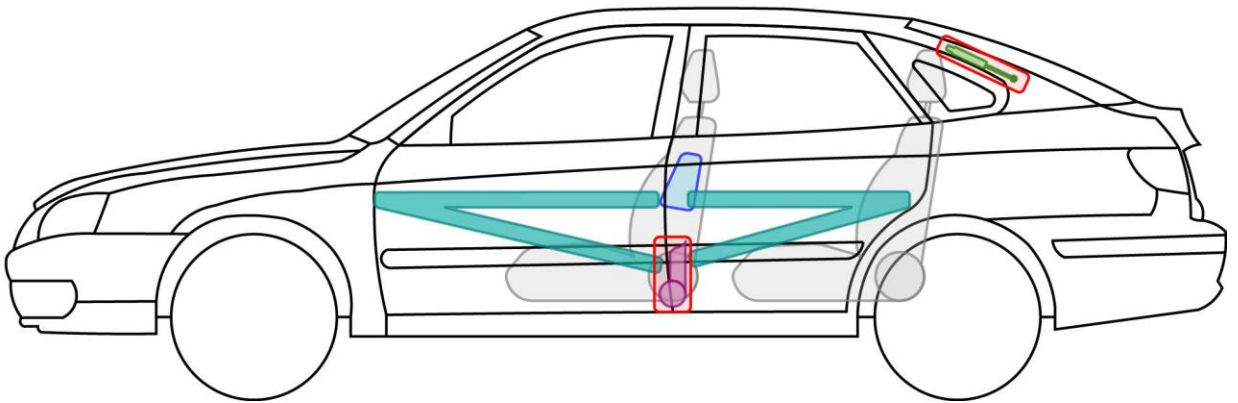
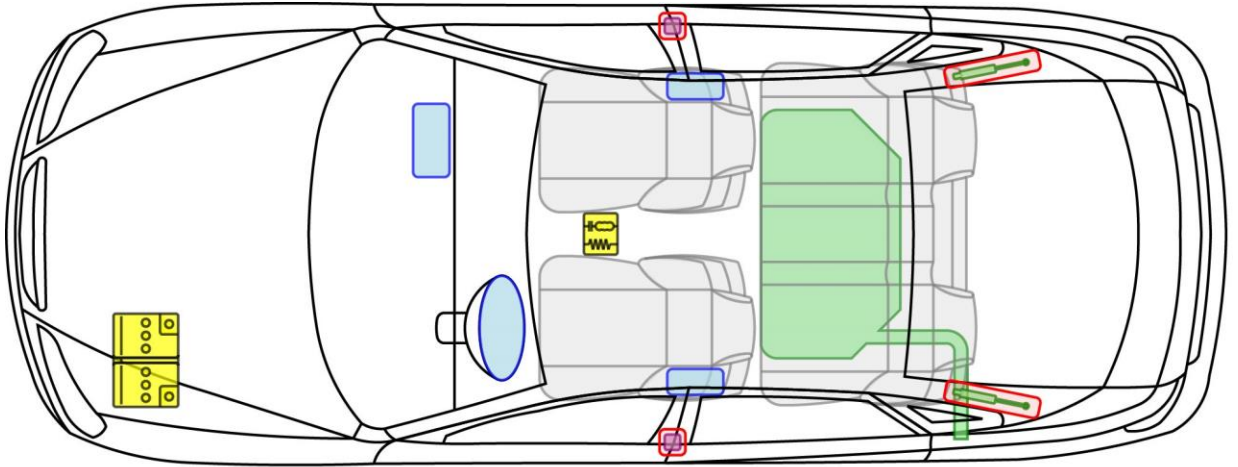

**Legende**

|   |                   |   |                            |   |                     |   |                            |
|---|-------------------|---|----------------------------|---|---------------------|---|----------------------------|
|  | Airbag            |  | Karosserie-<br>verstärkung |  | Steuergerät         |  | Gastank                    |
|  | Gas-<br>generator |  | Überroll-<br>schutz        |  | 12 V<br>Batterie    |  | Sicherheits-<br>ventil     |
|  | Gurt-<br>straffer |  | Gasdruck-<br>dämpfer       |  | Kraftstoff-<br>tank |  | Fußgänger-<br>schutzsystem |

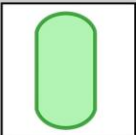
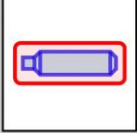
**Elantra**

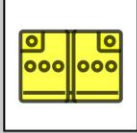

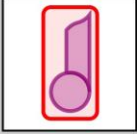
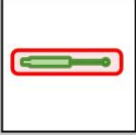





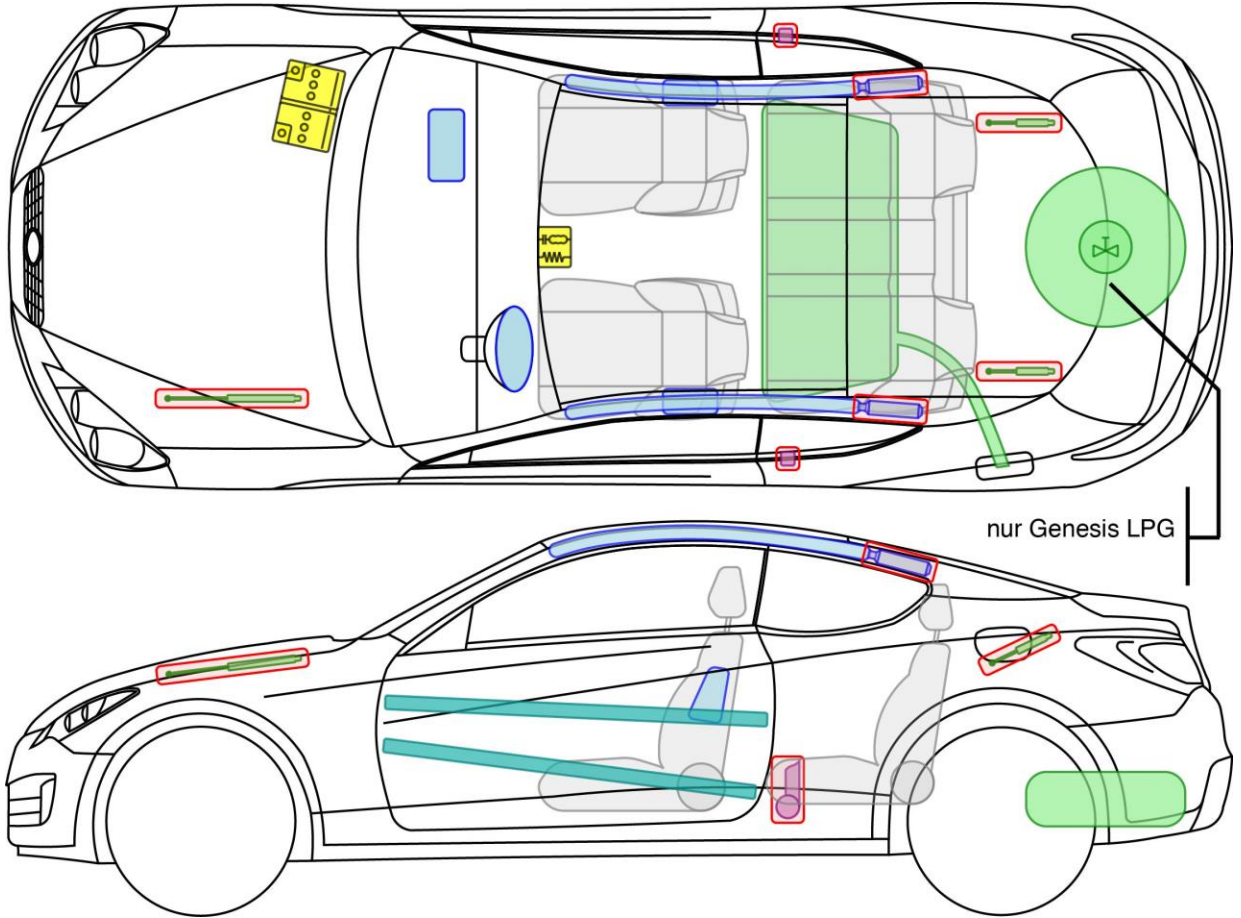

**Legende**

|   |                   |   |                            |   |                     |   |                            |
|---|-------------------|---|----------------------------|---|---------------------|---|----------------------------|
|  | Airbag            |  | Karosserie-<br>verstärkung |  | Steuergerät         |  | Gastank                    |
|  | Gas-<br>generator |  | Überroll-<br>schutz        |  | 12 V<br>Batterie    |  | Sicherheits-<br>ventil     |
|  | Gurt-<br>straffer |  | Gasdruck-<br>dämpfer       |  | Kraftstoff-<br>tank |  | Fußgänger-<br>schutzsystem |

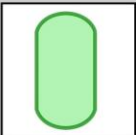
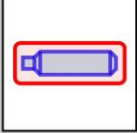
**Elantra**

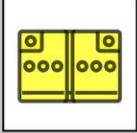

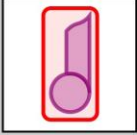
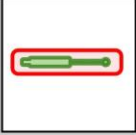





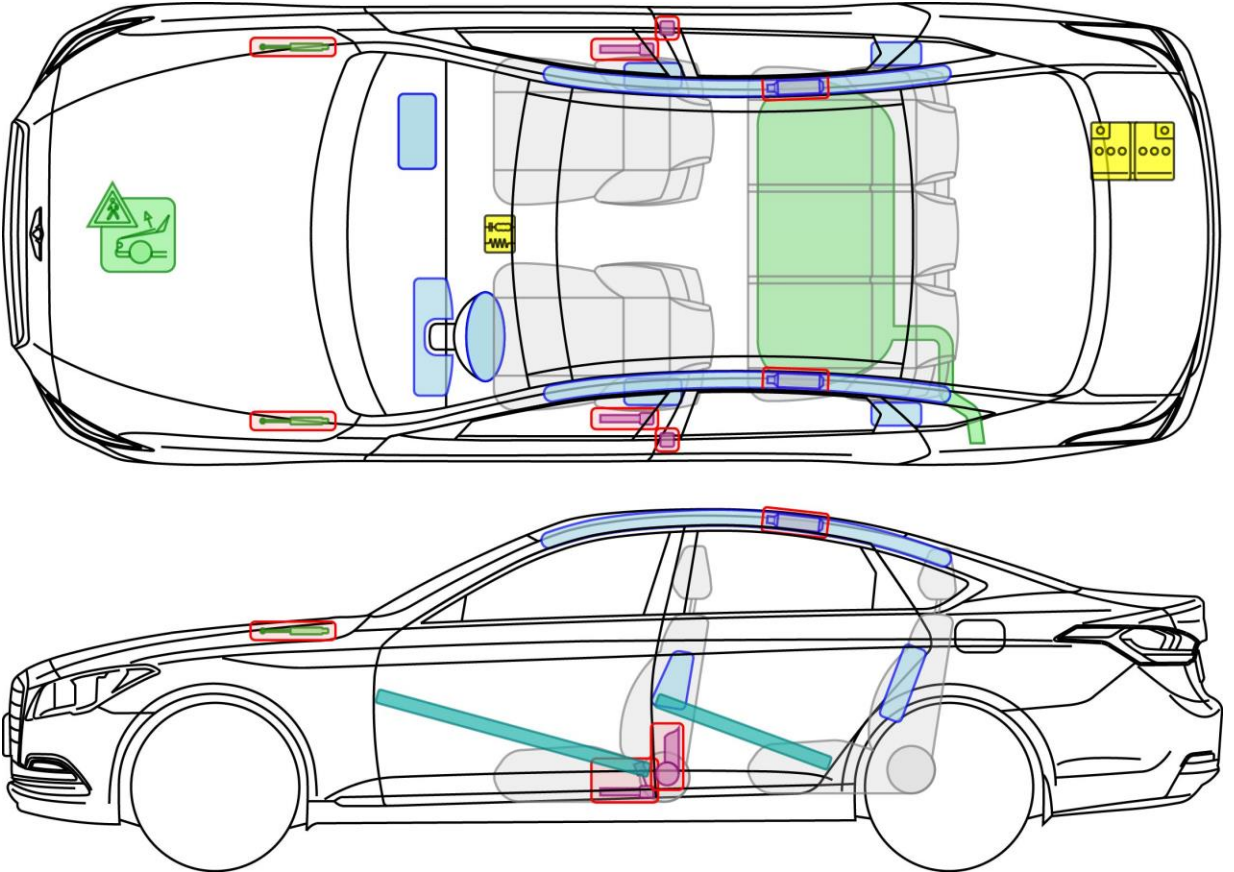

## Legende

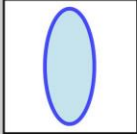
|   |                   |   |                            |   |                     |   |                            |
|---|-------------------|---|----------------------------|---|---------------------|---|----------------------------|
|  | Airbag            |  | Karosserie-<br>verstärkung |  | Steuergerät         |  | Gastank                    |
|  | Gas-<br>generator |  | Überroll-<br>schutz        |  | 12 V<br>Batterie    |  | Sicherheits-<br>ventil     |
|  | Gurt-<br>straffer |  | Gasdruck-<br>dämpfer       |  | Kraftstoff-<br>tank |  | Fußgänger-<br>schutzsystem |

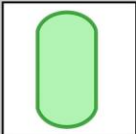
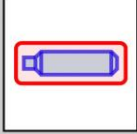
**Genesis Coupe**

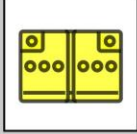

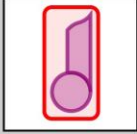
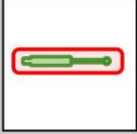





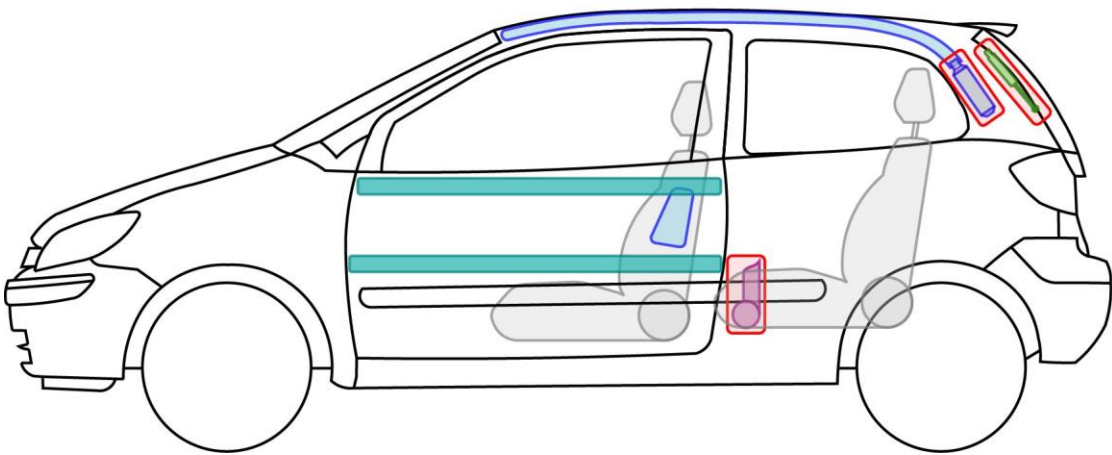
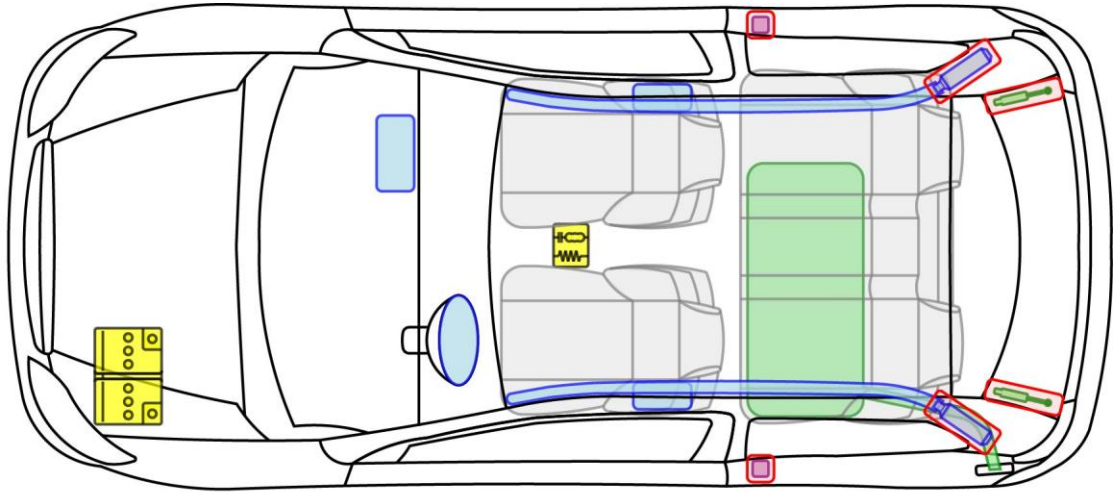

**Legende**

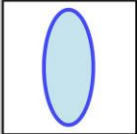
|   |                   |   |                            |   |                     |   |                            |
|---|-------------------|---|----------------------------|---|---------------------|---|----------------------------|
|  | Airbag            |  | Karosserie-<br>verstärkung |  | Steuergerät         |  | Gastank                    |
|  | Gas-<br>generator |  | Überroll-<br>schutz        |  | 12 V<br>Batterie    |  | Sicherheits-<br>ventil     |
|  | Gurt-<br>straffer |  | Gasdruck-<br>dämpfer       |  | Kraftstoff-<br>tank |  | Fußgänger-<br>schutzsystem |

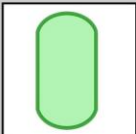
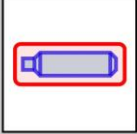
**Genesis**

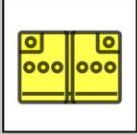

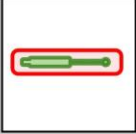





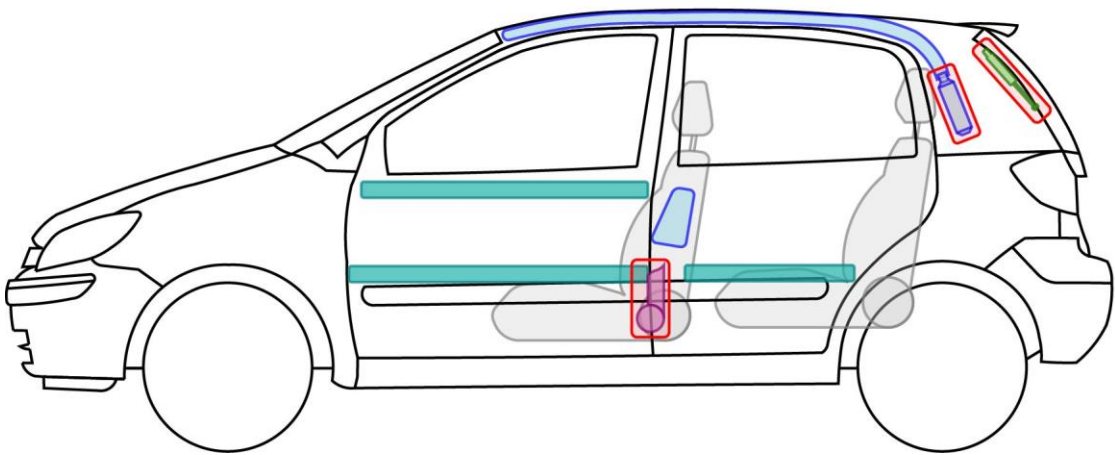
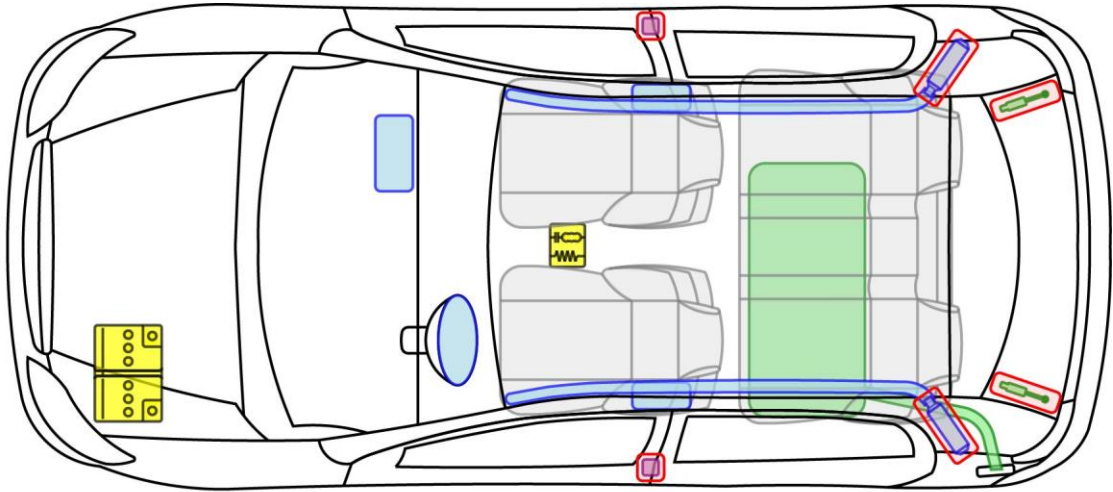

**Legende**

|   |                   |   |                            |   |                     |   |                            |
|---|-------------------|---|----------------------------|---|---------------------|---|----------------------------|
|  | Airbag            |  | Karosserie-<br>verstärkung |  | Steuergerät         |  | Gastank                    |
|  | Gas-<br>generator |  | Überroll-<br>schutz        |  | 12 V<br>Batterie    |  | Sicherheits-<br>ventil     |
|  | Gurt-<br>straffer |  | Gasdruck-<br>dämpfer       |  | Kraftstoff-<br>tank |  | Fußgänger-<br>schutzsystem |

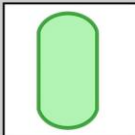
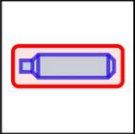
**Getz**

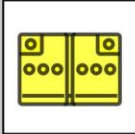

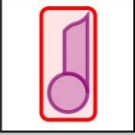
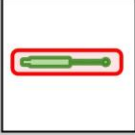
**Legende**







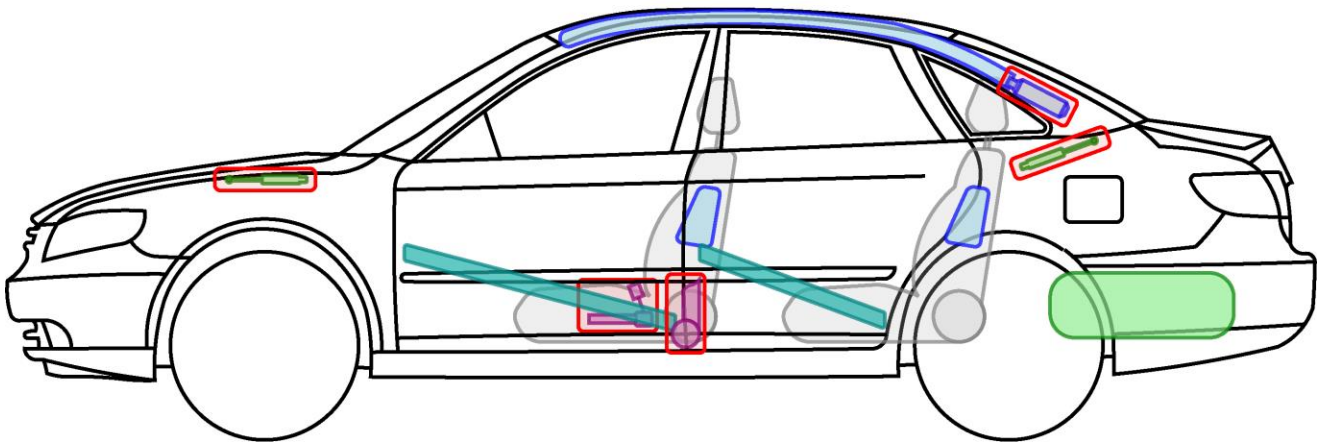
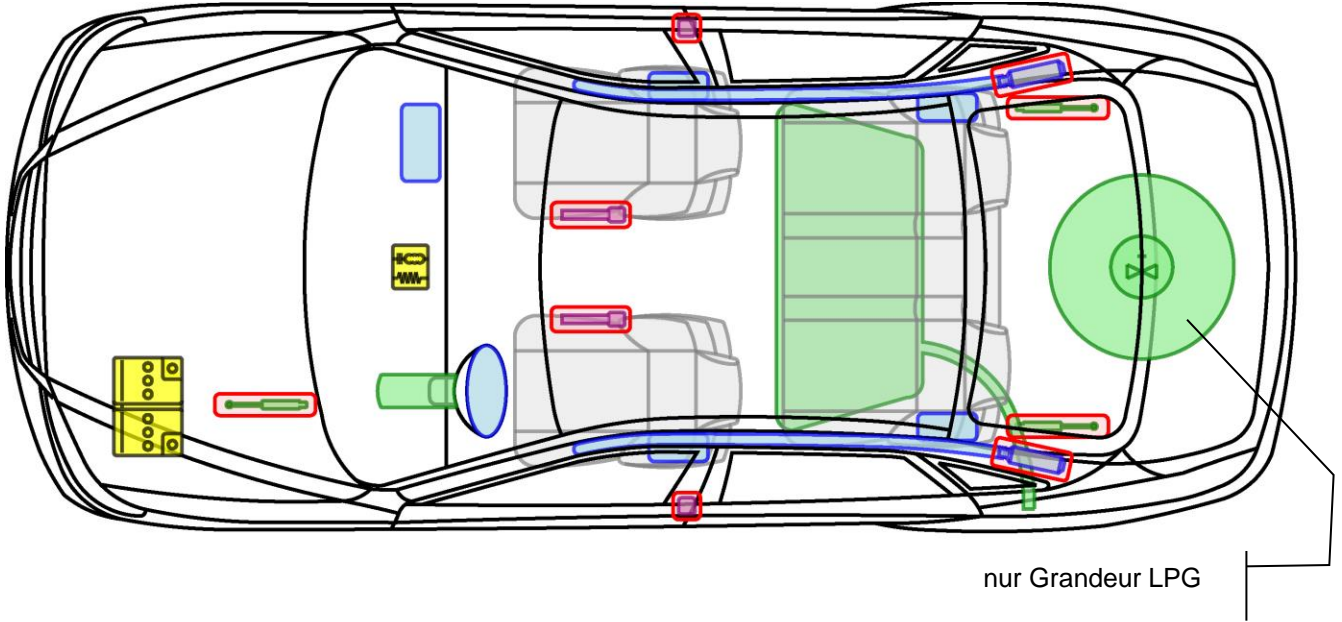

|   |                   |   |                            |   |                     |   |                            |
|---|-------------------|---|----------------------------|---|---------------------|---|----------------------------|
|  | Airbag            |  | Karosserie-<br>verstärkung |  | Steuergerät         |  | Gastank                    |
|  | Gas-<br>generator |  | Überroll-<br>schutz        |  | 12 V<br>Batterie    |  | Sicherheits-<br>ventil     |
|  | Gurt-<br>straffer |  | Gasdruck-<br>dämpfer       |  | Kraftstoff-<br>tank |  | Fußgänger-<br>schutzsystem |

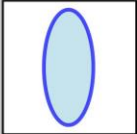
**Getz**

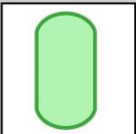
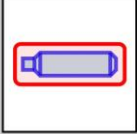

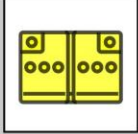

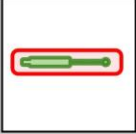





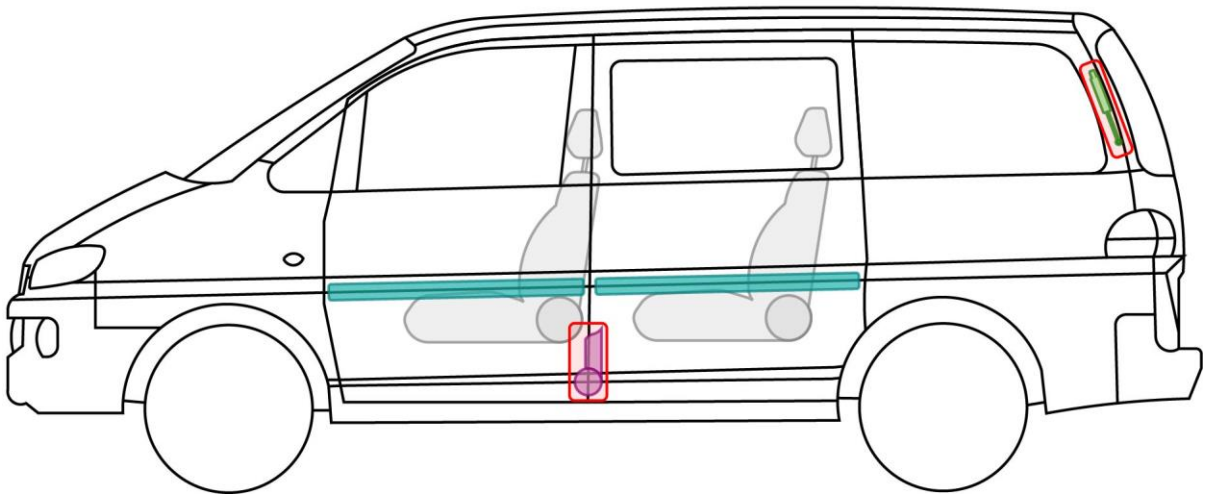
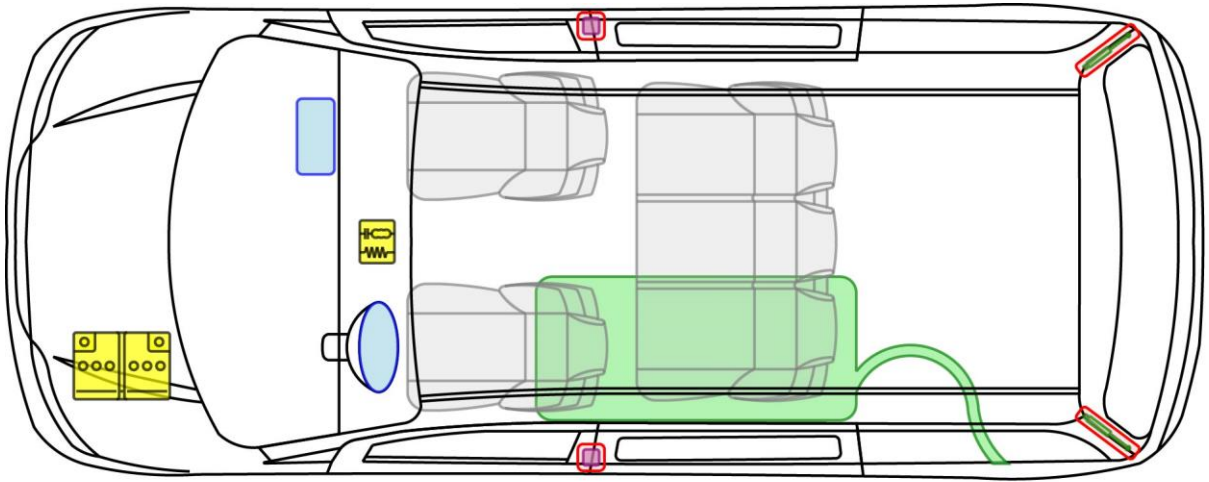

**Legende**

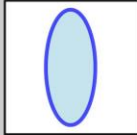
|   |                   |   |                            |   |                     |   |                            |
|---|-------------------|---|----------------------------|---|---------------------|---|----------------------------|
|  | Airbag            |  | Karosserie-<br>verstärkung |  | Steuergerät         |  | Gastank                    |
|  | Gas-<br>generator |  | Überroll-<br>schutz        |  | 12 V<br>Batterie    |  | Sicherheits-<br>ventil     |
|  | Gurt-<br>straffer |  | Gasdruck-<br>dämpfer       |  | Kraftstoff-<br>tank |  | Fußgänger-<br>schutzsystem |

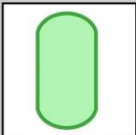
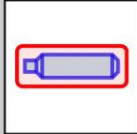
**Grandeur**

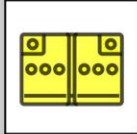

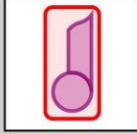
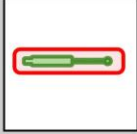





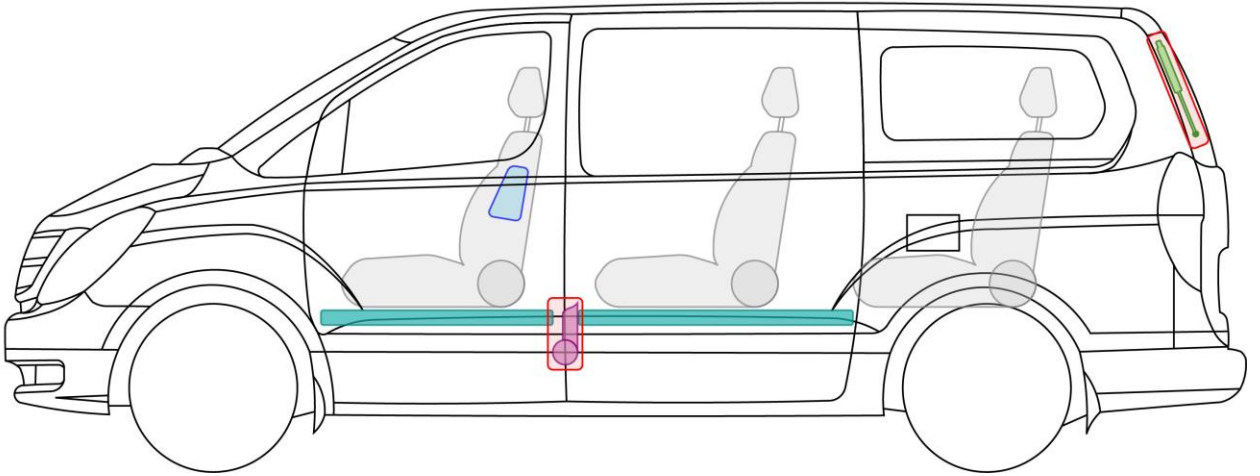
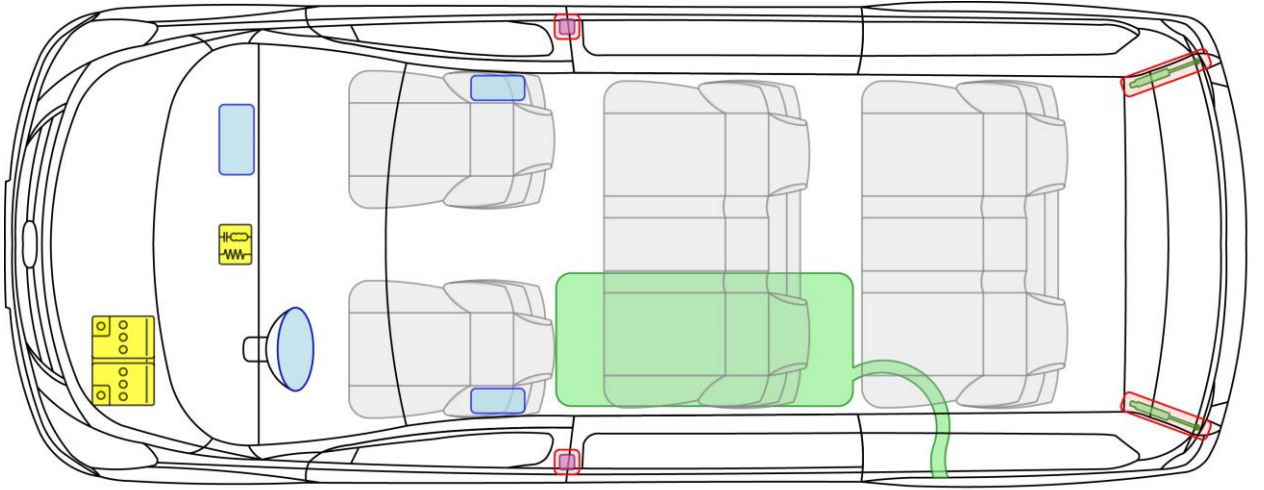

**Legende**

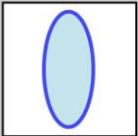
|   |                   |   |                            |   |                     |   |                            |
|---|-------------------|---|----------------------------|---|---------------------|---|----------------------------|
|  | Airbag            |  | Karosserie-<br>verstärkung |  | Steuergerät         |  | Gastank                    |
|  | Gas-<br>generator |  | Überroll-<br>schutz        |  | 12 V<br>Batterie    |  | Sicherheits-<br>ventil     |
|  | Gurt-<br>straffer |  | Gasdruck-<br>dämpfer       |  | Kraftstoff-<br>tank |  | Fußgänger-<br>schutzsystem |

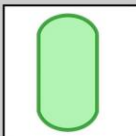
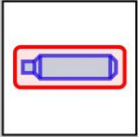
H-1

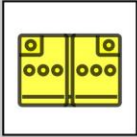

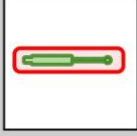





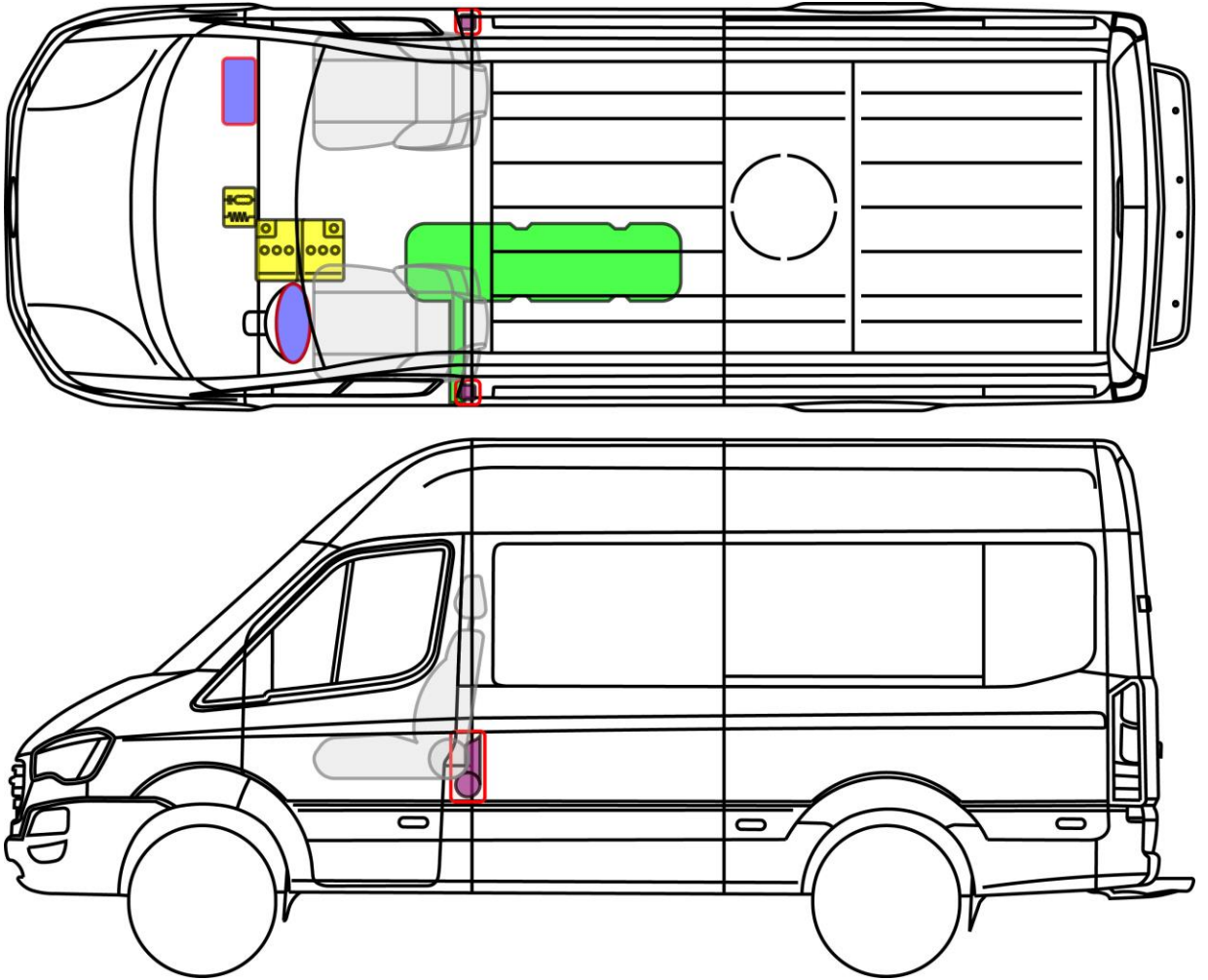

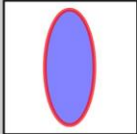

**Legende**

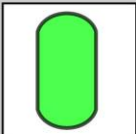
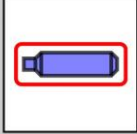
|   |                   |   |                            |   |                     |   |                            |
|---|-------------------|---|----------------------------|---|---------------------|---|----------------------------|
|  | Airbag            |  | Karosserie-<br>verstärkung |  | Steuergerät         |  | Gastank                    |
|  | Gas-<br>generator |  | Überroll-<br>schutz        |  | 12 V<br>Batterie    |  | Sicherheits-<br>ventil     |
|  | Gurt-<br>straffer |  | Gasdruck-<br>dämpfer       |  | Kraftstoff-<br>tank |  | Fußgänger-<br>schutzsystem |

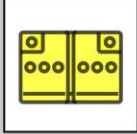
**H-1**

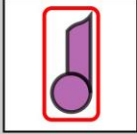







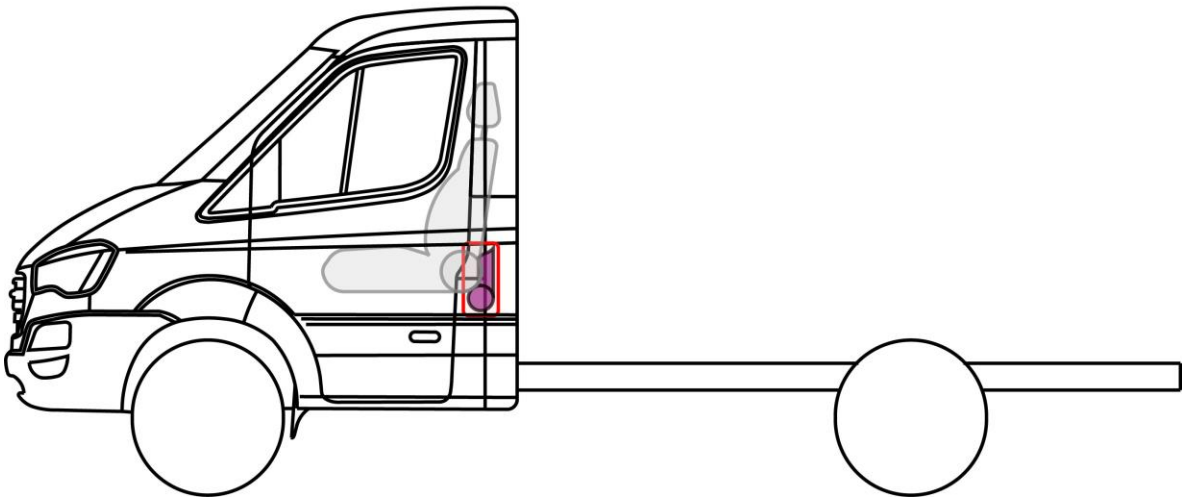
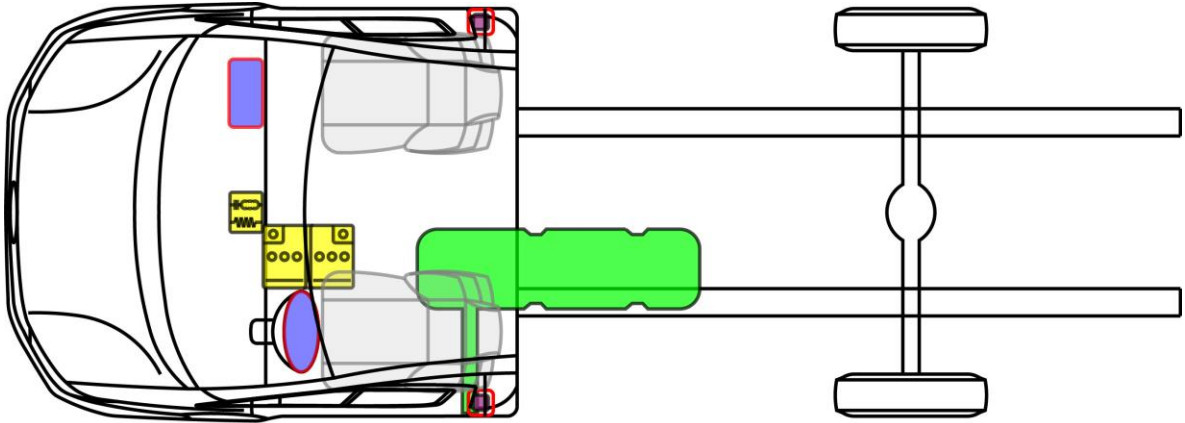

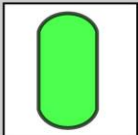

**Legende**

|   |                   |   |                            |   |                     |   |                            |
|---|-------------------|---|----------------------------|---|---------------------|---|----------------------------|
|  | Airbag            |  | Karosserie-<br>verstärkung |  | Steuergerät         |  | Gastank                    |
|  | Gas-<br>generator |  | Überroll-<br>schutz        |  | 12 V<br>Batterie    |  | Sicherheits-<br>ventil     |
|  | Gurt-<br>straffer |  | Gasdruck-<br>dämpfer       |  | Kraftstoff-<br>tank |  | Fußgänger-<br>schutzsystem |

**H-350**

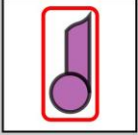







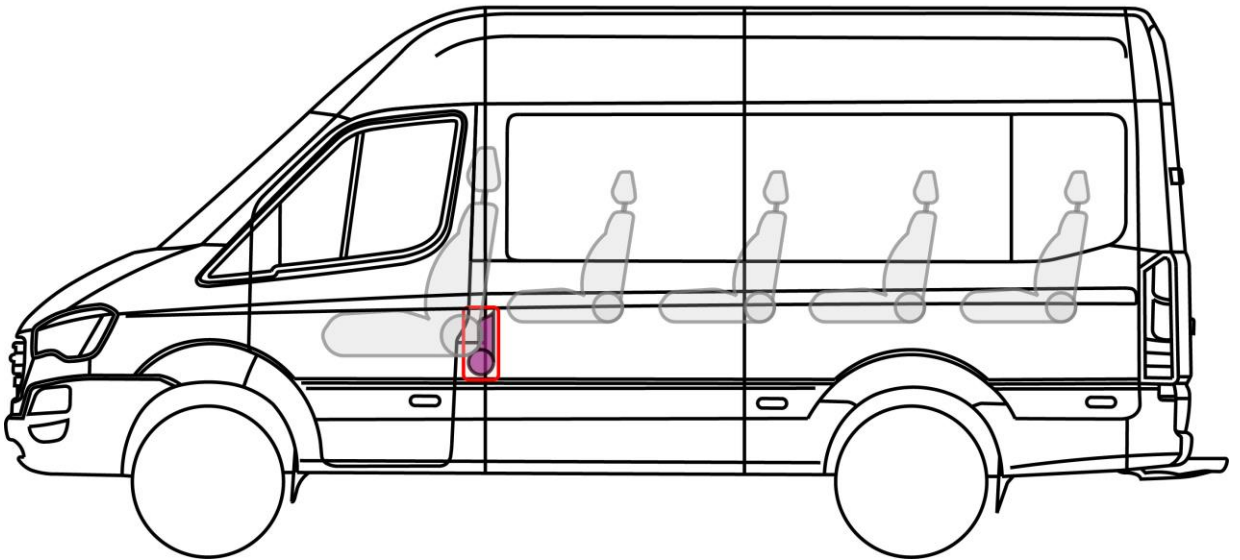
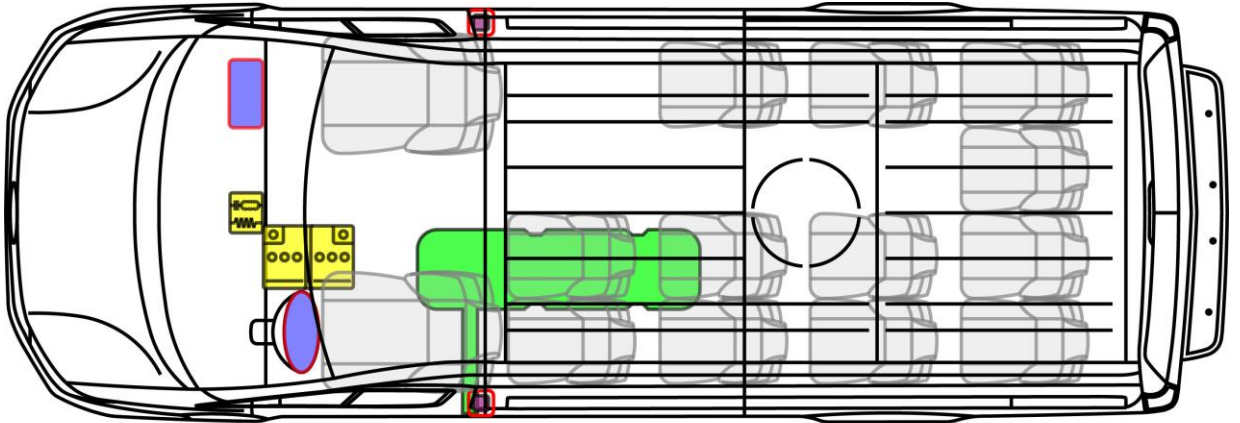

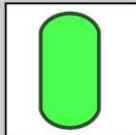
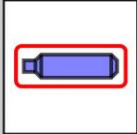

## Legende

|   |                   |   |                            |   |                     |   |                            |
|---|-------------------|---|----------------------------|---|---------------------|---|----------------------------|
|  | Airbag            |  | Karosserie-<br>verstärkung |  | Steuergerät         |  | Gastank                    |
|  | Gas-<br>generator |  | Überroll-<br>schutz        |  | 12 V<br>Batterie    |  | Sicherheits-<br>ventil     |
|  | Gurt-<br>straffer |  | Gasdruck-<br>dämpfer       |  | Kraftstoff-<br>tank |  | Fußgänger-<br>schutzsystem |

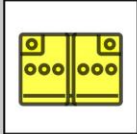
**H-350**

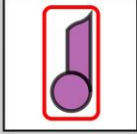







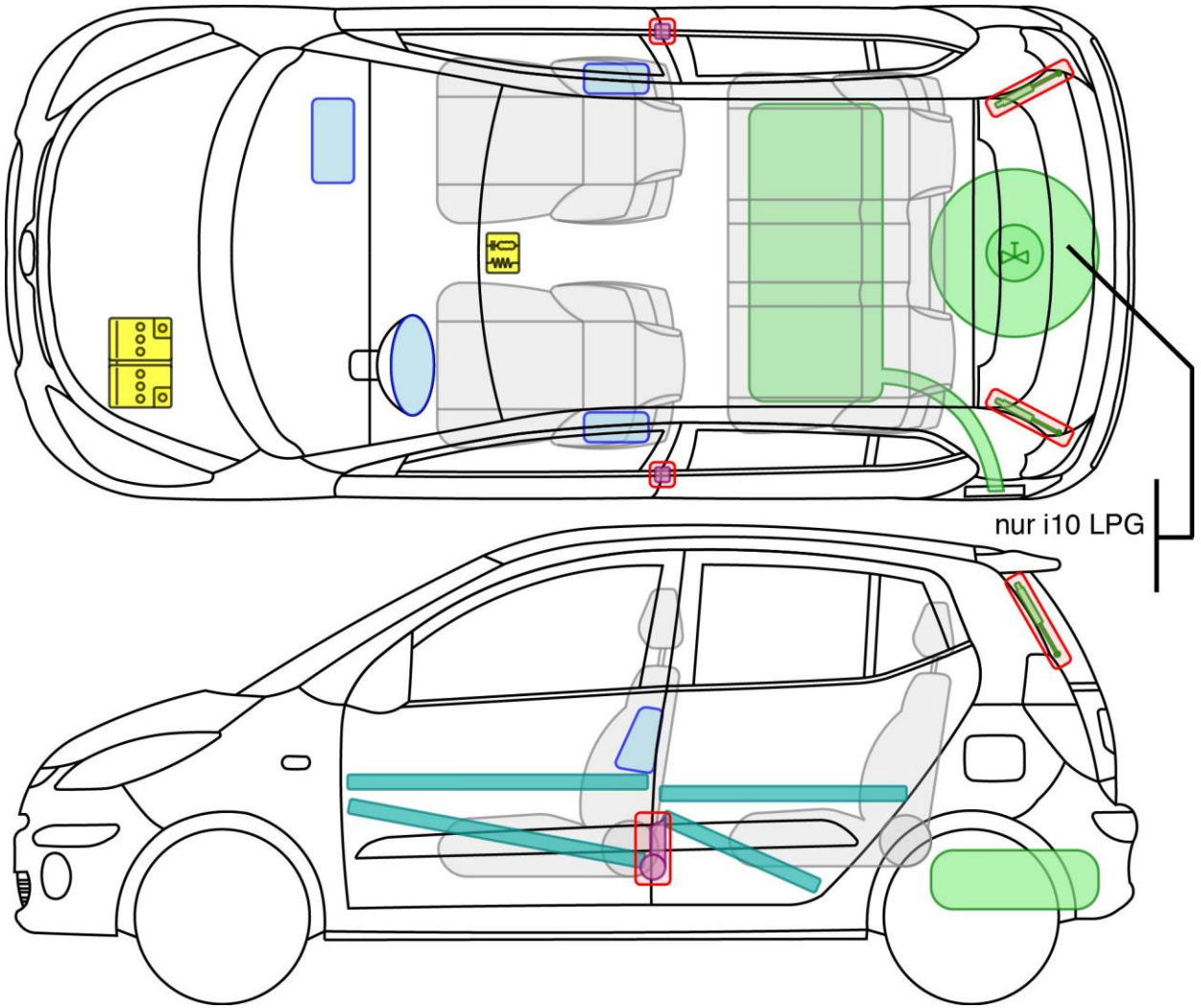

**Legende**

|   |                   |   |                            |   |                     |   |                            |
|---|-------------------|---|----------------------------|---|---------------------|---|----------------------------|
|  | Airbag            |  | Karosserie-<br>verstärkung |  | Steuergerät         |  | Gastank                    |
|  | Gas-<br>generator |  | Überroll-<br>schutz        |  | 12 V<br>Batterie    |  | Sicherheits-<br>ventil     |
|  | Gurt-<br>straffer |  | Gasdruck-<br>dämpfer       |  | Kraftstoff-<br>tank |  | Fußgänger-<br>schutzsystem |

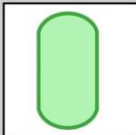
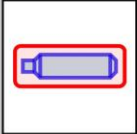
**H-350**



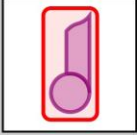
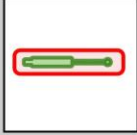





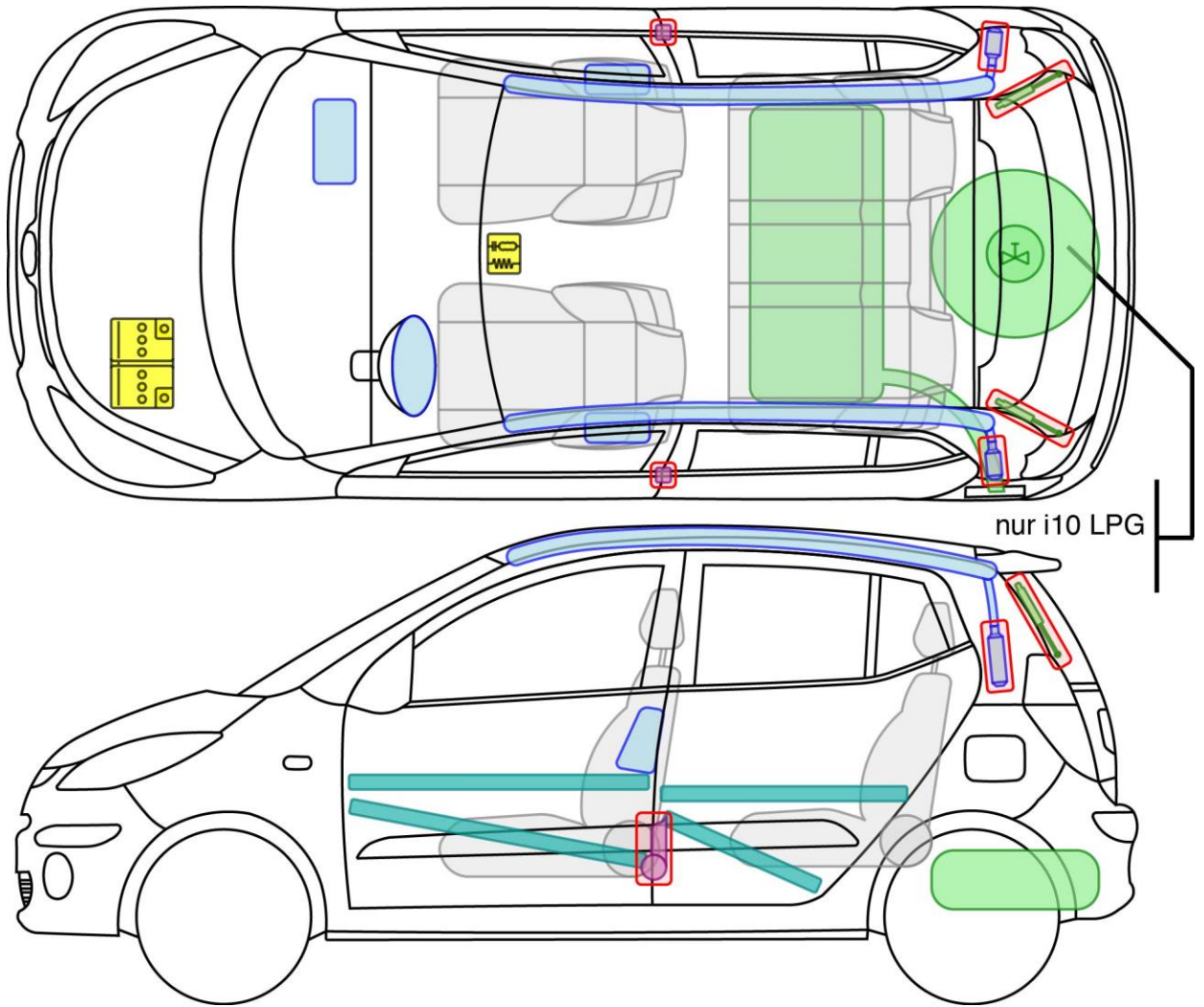

**Legende**

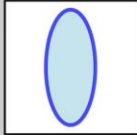
|   |                   |   |                            |   |                     |   |                            |
|---|-------------------|---|----------------------------|---|---------------------|---|----------------------------|
|  | Airbag            |  | Karosserie-<br>verstärkung |  | Steuergerät         |  | Gastank                    |
|  | Gas-<br>generator |  | Überroll-<br>schutz        |  | 12 V<br>Batterie    |  | Sicherheits-<br>ventil     |
|  | Gurt-<br>straffer |  | Gasdruck-<br>dämpfer       |  | Kraftstoff-<br>tank |  | Fußgänger-<br>schutzsystem |

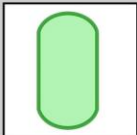
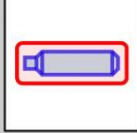
**i10**

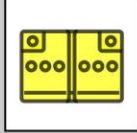

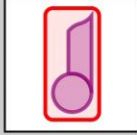
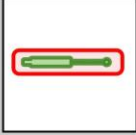
**Legende**







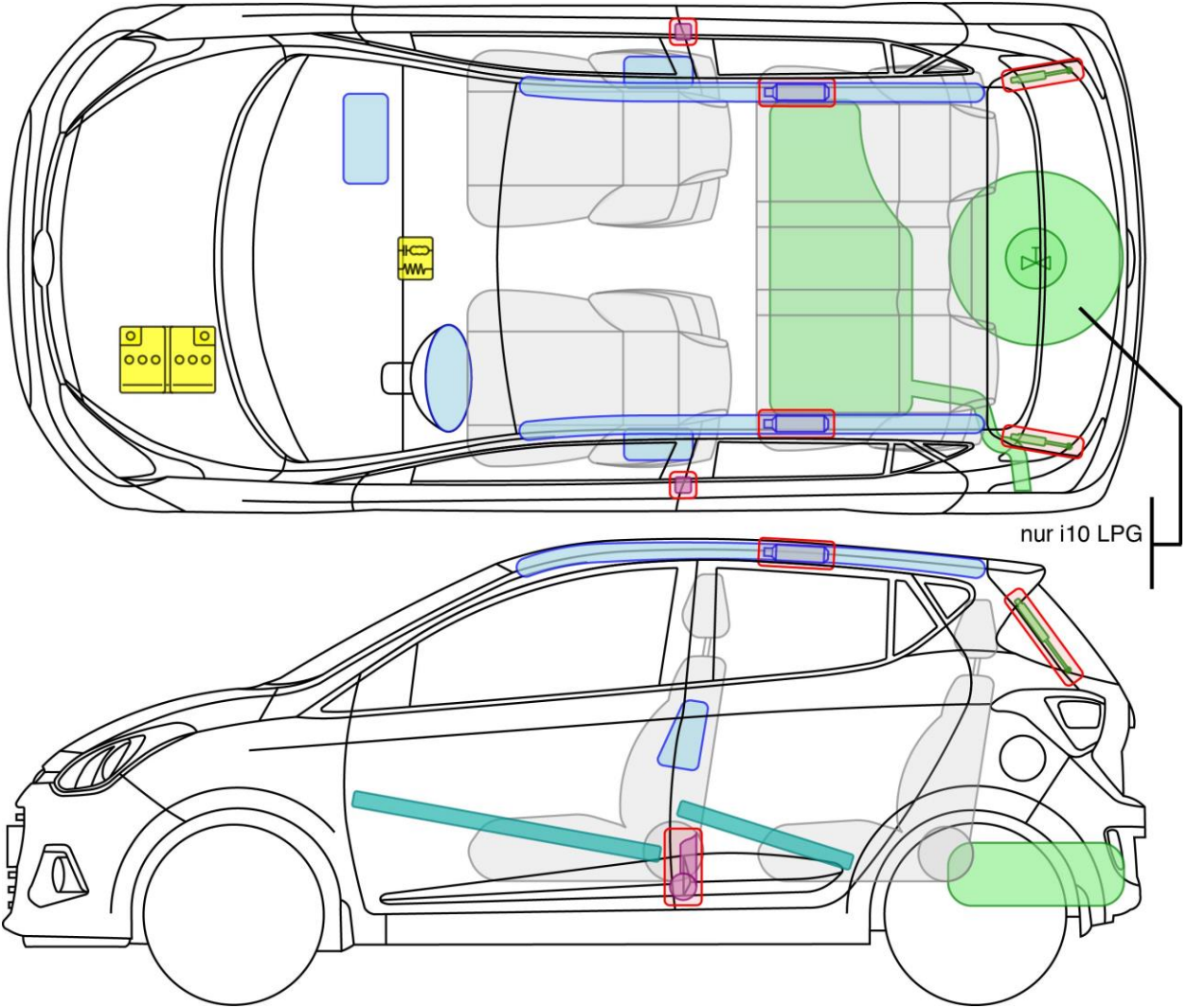

|   |                   |   |                            |   |                     |   |                            |
|---|-------------------|---|----------------------------|---|---------------------|---|----------------------------|
|  | Airbag            |  | Karosserie-<br>verstärkung |  | Steuergerät         |  | Gastank                    |
|  | Gas-<br>generator |  | Überroll-<br>schutz        |  | 12 V<br>Batterie    |  | Sicherheits-<br>ventil     |
|  | Gurt-<br>straffer |  | Gasdruck-<br>dämpfer       |  | Kraftstoff-<br>tank |  | Fußgänger-<br>schutzsystem |

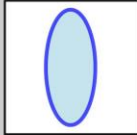
**i10**

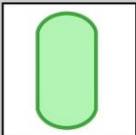
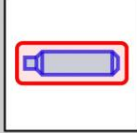

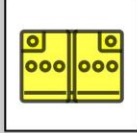

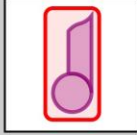
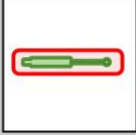
**Legende**

|   |                   |   |                            |   |                     |   |                            |
|---|-------------------|---|----------------------------|---|---------------------|---|----------------------------|
|  | Airbag            |  | Karosserie-<br>verstärkung |  | Steuergerät         |  | Gastank                    |
|  | Gas-<br>generator |  | Überroll-<br>schutz        |  | 12 V<br>Batterie    |  | Sicherheits-<br>ventil     |
|  | Gurt-<br>straffer |  | Gasdruck-<br>dämpfer       |  | Kraftstoff-<br>tank |  | Fußgänger-<br>schutzsystem |



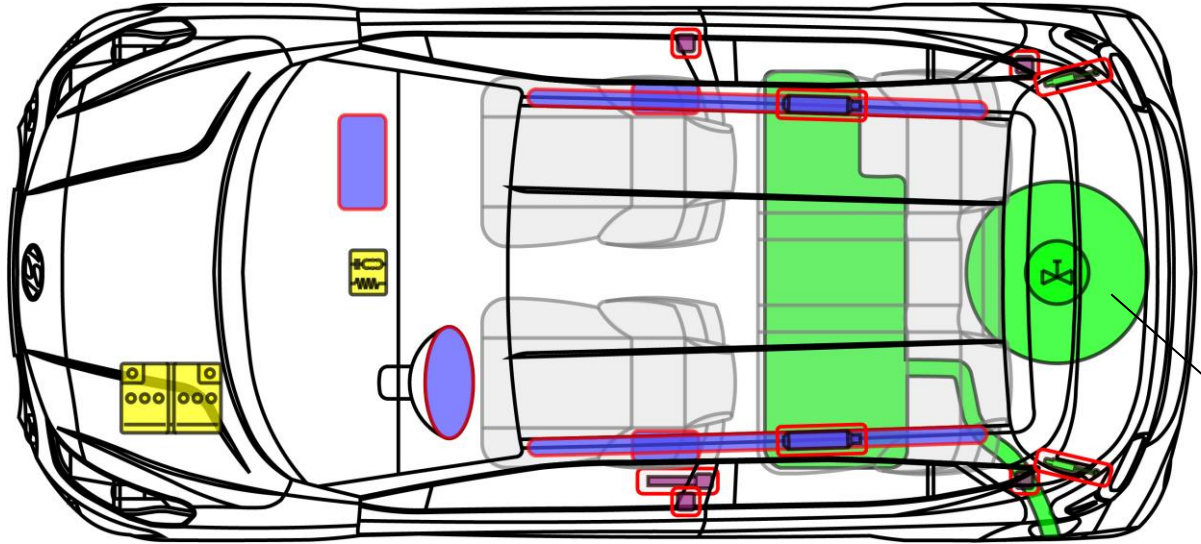



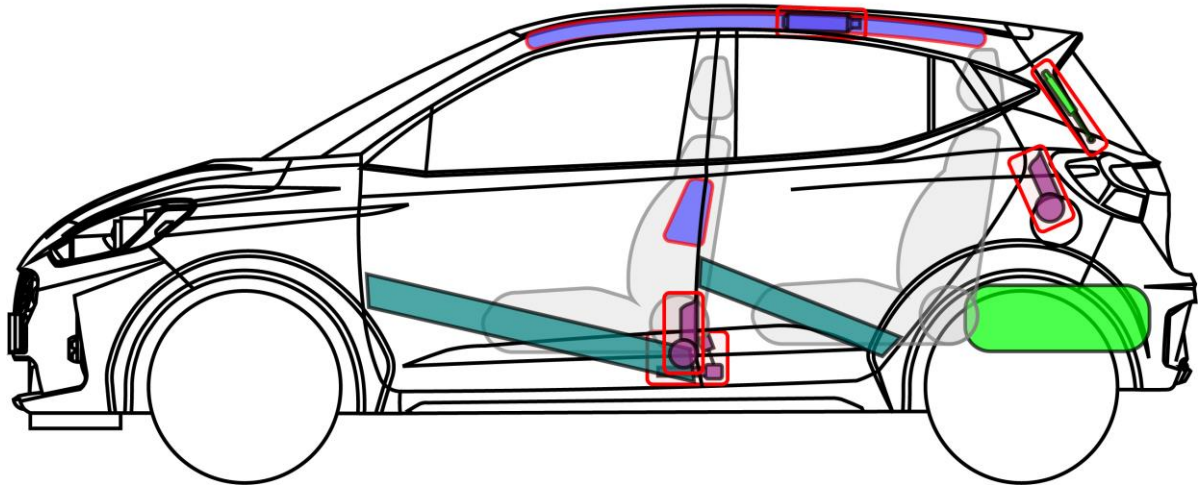

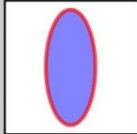
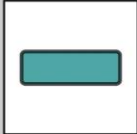

**i10**

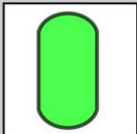
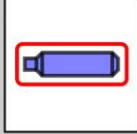

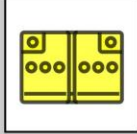
nur i10 LPG

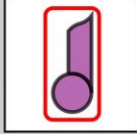







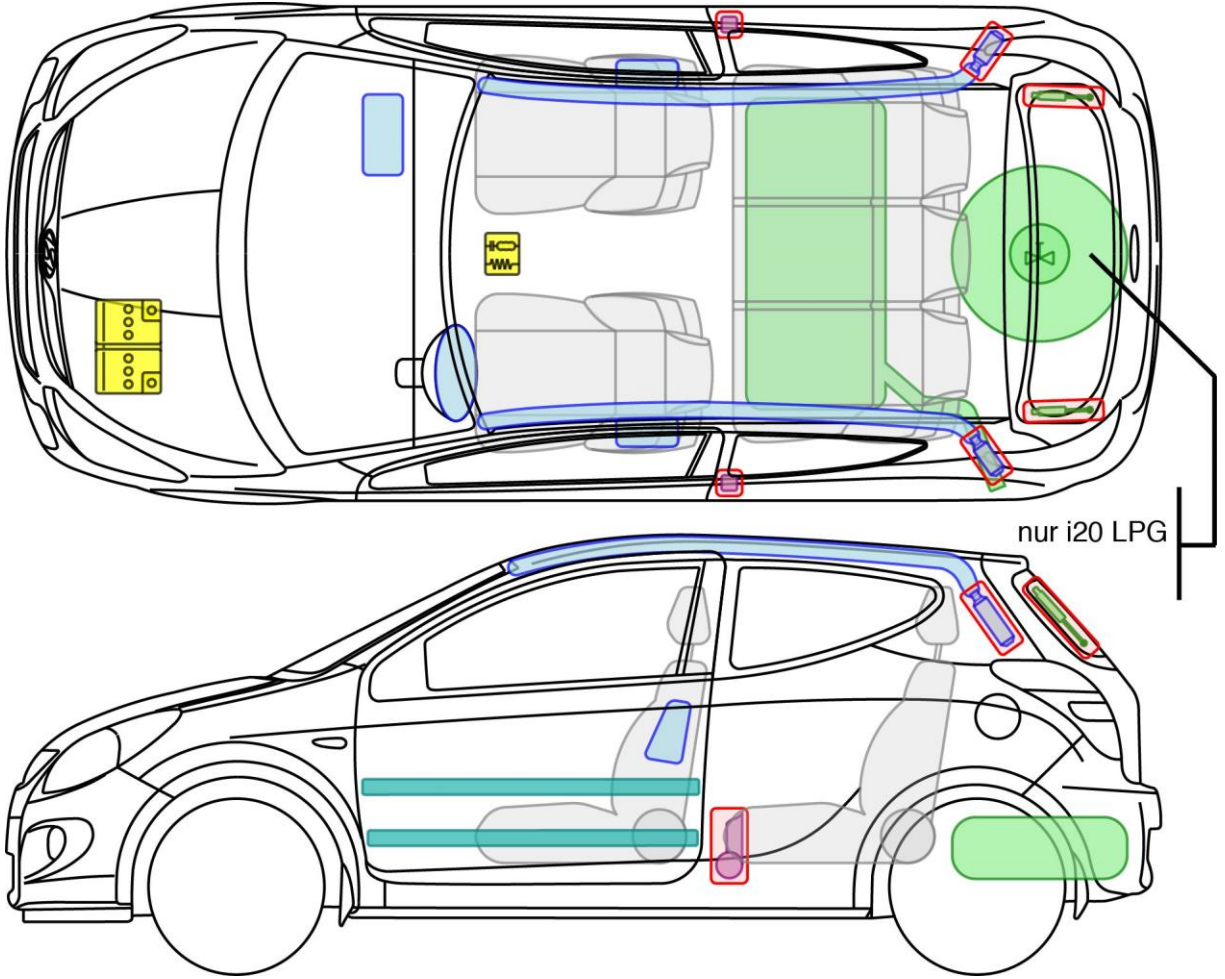

**Legende**

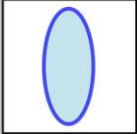
|   |                   |   |                            |   |                     |   |                            |
|---|-------------------|---|----------------------------|---|---------------------|---|----------------------------|
|  | Airbag            |  | Karosserie-<br>verstärkung |  | Steuergerät         |  | Gastank                    |
|  | Gas-<br>generator |  | Überroll-<br>schutz        |  | 12 V<br>Batterie    |  | Sicherheits-<br>ventil     |
|  | Gurt-<br>straffer |  | Gasdruck-<br>dämpfer       |  | Kraftstoff-<br>tank |  | Fußgänger-<br>schutzsystem |

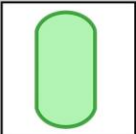
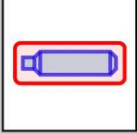
**i10**

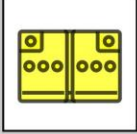

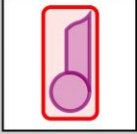
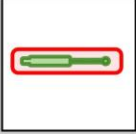
**Legende**





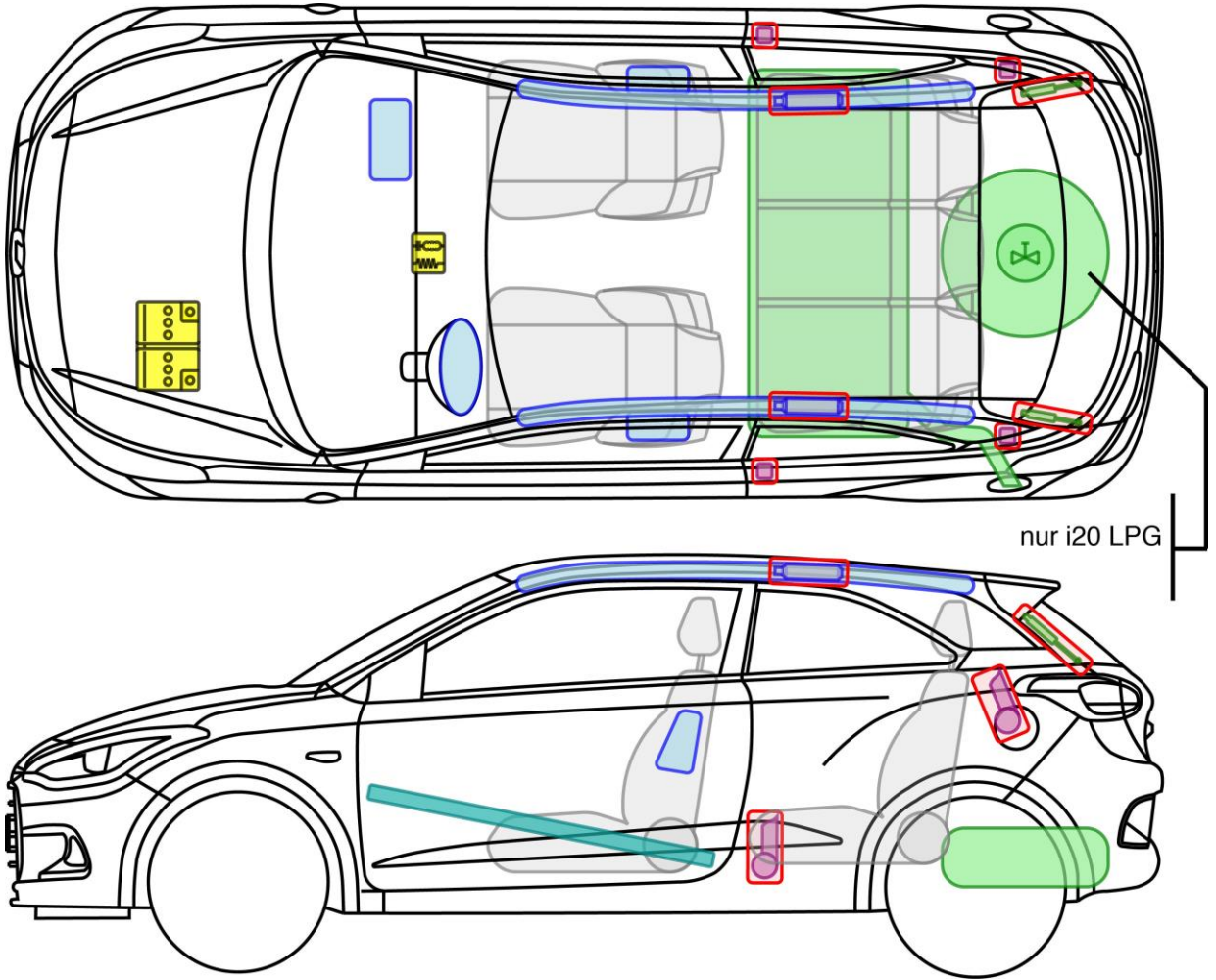



|   |                   |   |                            |   |                     |   |                            |
|---|-------------------|---|----------------------------|---|---------------------|---|----------------------------|
|  | Airbag            |  | Karosserie-<br>verstärkung |  | Steuergerät         |  | Gastank                    |
|  | Gas-<br>generator |  | Überroll-<br>schutz        |  | 12 V<br>Batterie    |  | Sicherheits-<br>ventil     |
|  | Gurt-<br>straffer |  | Gasdruck-<br>dämpfer       |  | Kraftstoff-<br>tank |  | Fußgänger-<br>schutzsystem |

**i20**

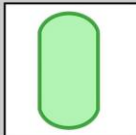
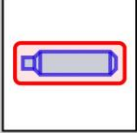

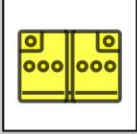
nur i20 LPG

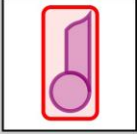
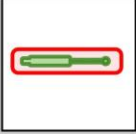





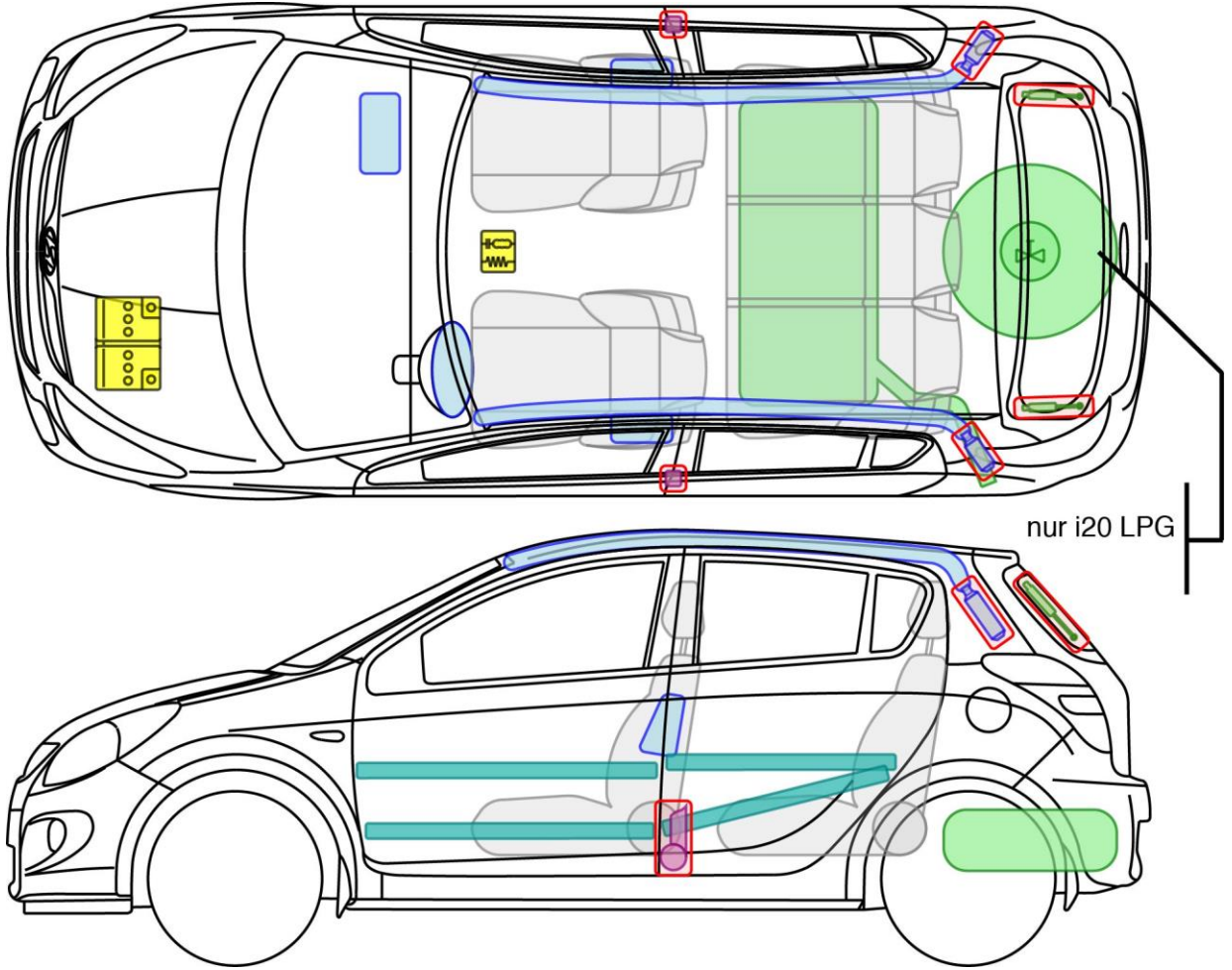

**Legende**

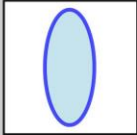
|   |                   |   |                            |   |                     |   |                            |
|---|-------------------|---|----------------------------|---|---------------------|---|----------------------------|
|  | Airbag            |  | Karosserie-<br>verstärkung |  | Steuergerät         |  | Gastank                    |
|  | Gas-<br>generator |  | Überroll-<br>schutz        |  | 12 V<br>Batterie    |  | Sicherheits-<br>ventil     |
|  | Gurt-<br>straffer |  | Gasdruck-<br>dämpfer       |  | Kraftstoff-<br>tank |  | Fußgänger-<br>schutzsystem |

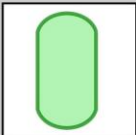
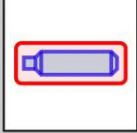
**i20 Coupe**

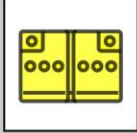

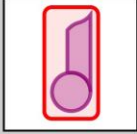
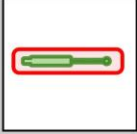





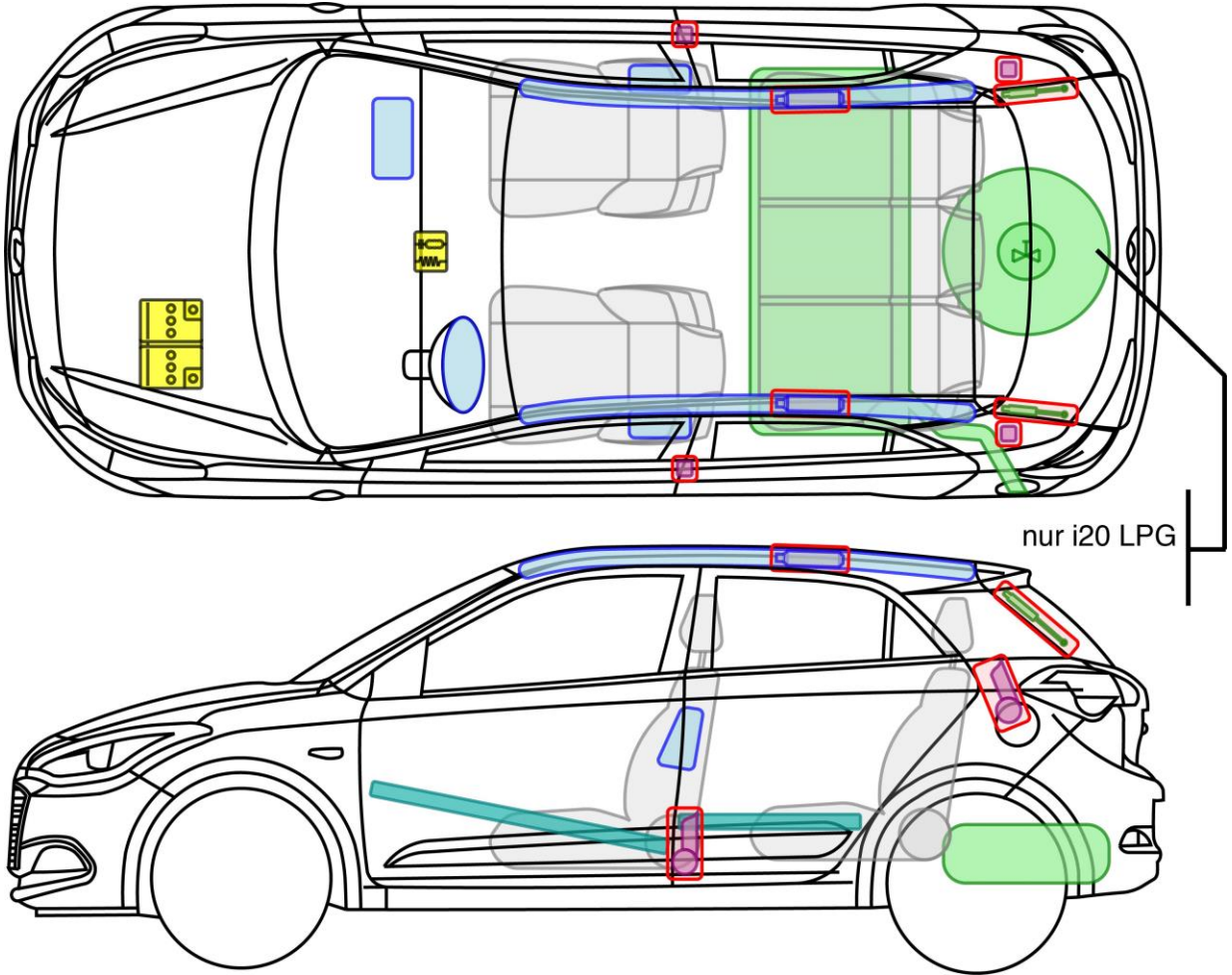

**Legende**

|   |                   |   |                            |   |                     |   |                            |
|---|-------------------|---|----------------------------|---|---------------------|---|----------------------------|
|  | Airbag            |  | Karosserie-<br>verstärkung |  | Steuergerät         |  | Gastank                    |
|  | Gas-<br>generator |  | Überroll-<br>schutz        |  | 12 V<br>Batterie    |  | Sicherheits-<br>ventil     |
|  | Gurt-<br>straffer |  | Gasdruck-<br>dämpfer       |  | Kraftstoff-<br>tank |  | Fußgänger-<br>schutzsystem |

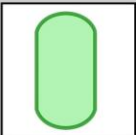
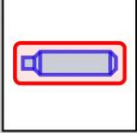
**i20**

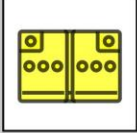

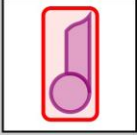
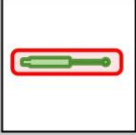
**Legende**

|   |                   |   |                            |   |                     |   |                            |
|---|-------------------|---|----------------------------|---|---------------------|---|----------------------------|
|  | Airbag            |  | Karosserie-<br>verstärkung |  | Steuergerät         |  | Gastank                    |
|  | Gas-<br>generator |  | Überroll-<br>schutz        |  | 12 V<br>Batterie    |  | Sicherheits-<br>ventil     |
|  | Gurt-<br>straffer |  | Gasdruck-<br>dämpfer       |  | Kraftstoff-<br>tank |  | Fußgänger-<br>schutzsystem |



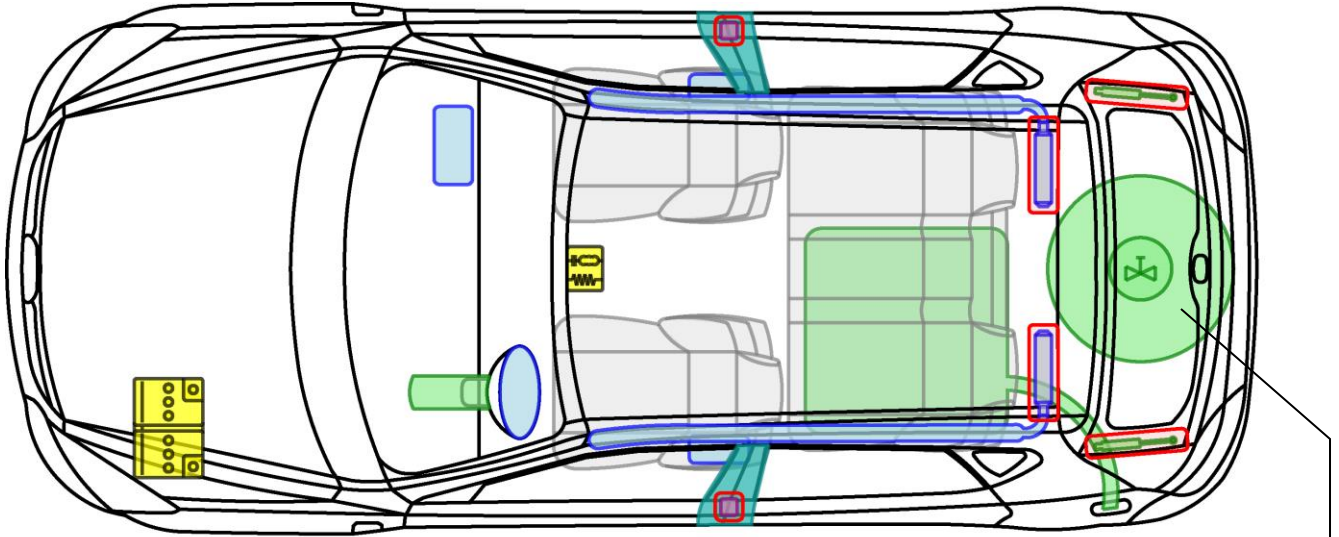



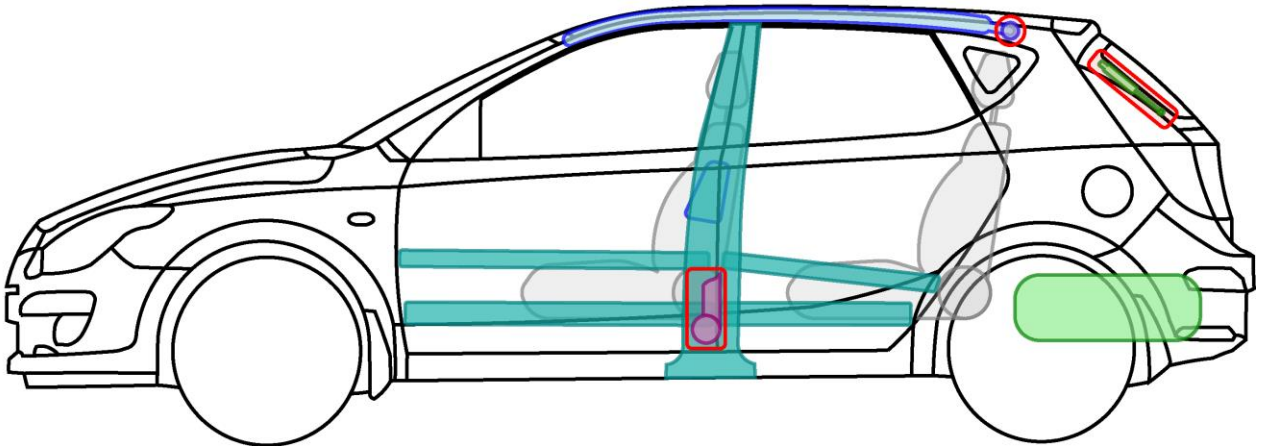

**i20**

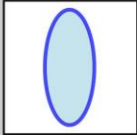

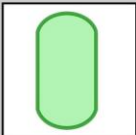
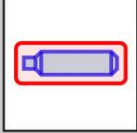
nur i30 LPG

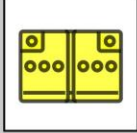

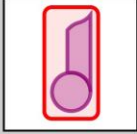
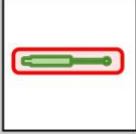





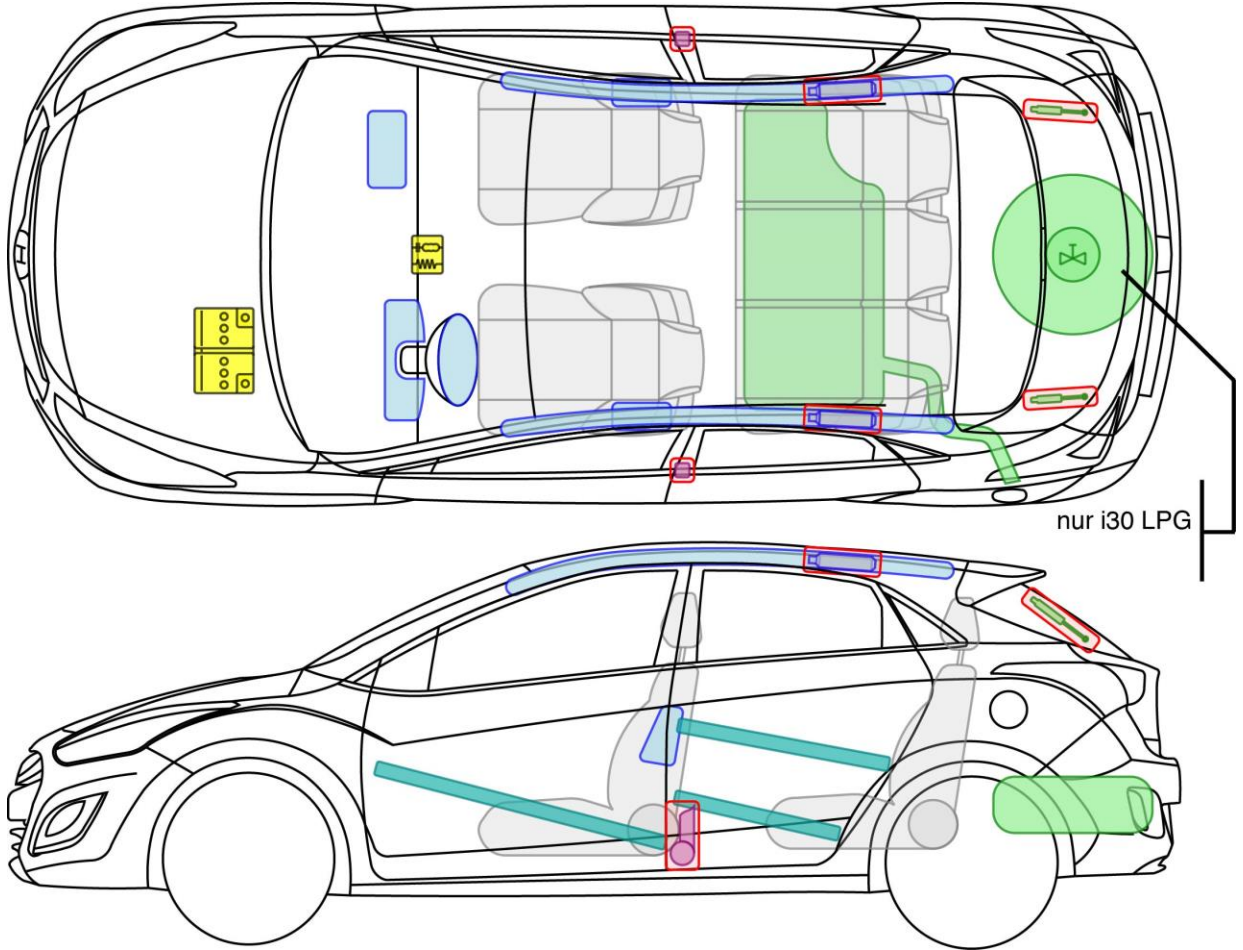

**Legende**

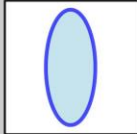
|   |               |   |                        |   |                 |   |                        |
|---|---------------|---|------------------------|---|-----------------|---|------------------------|
|  | Airbag        |  | Karosserie-verstärkung |  | Steuergerät     |  | Gastank                |
|  | Gas-generator |  | Überroll-schutz        |  | 12 V Batterie   |  | Sicherheits-ventil     |
|  | Gurt-straffer |  | Gasdruck-dämpfer       |  | Kraftstoff-tank |  | Fußgänger-schutzsystem |

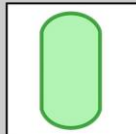
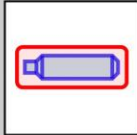
**i30**

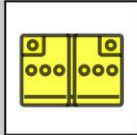

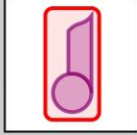
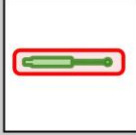
**Legende**

|   |                   |   |                            |   |                     |   |                            |
|---|-------------------|---|----------------------------|---|---------------------|---|----------------------------|
|  | Airbag            |  | Karosserie-<br>verstärkung |  | Steuergerät         |  | Gastank                    |
|  | Gas-<br>generator |  | Überroll-<br>schutz        |  | 12 V<br>Batterie    |  | Sicherheits-<br>ventil     |
|  | Gurt-<br>straffer |  | Gasdruck-<br>dämpfer       |  | Kraftstoff-<br>tank |  | Fußgänger-<br>schutzsystem |





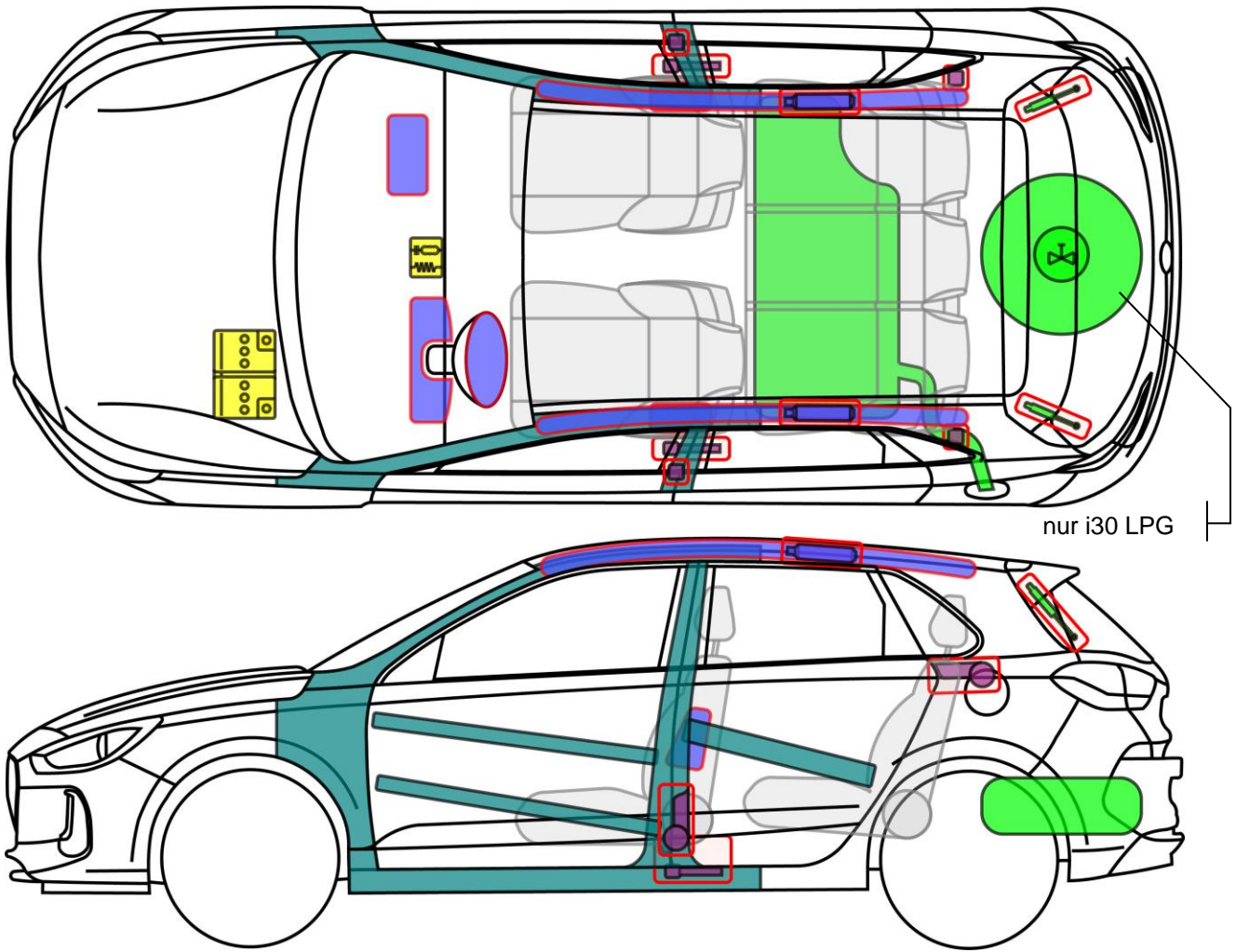



**i30**

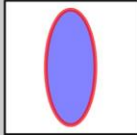

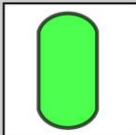
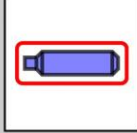

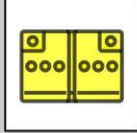
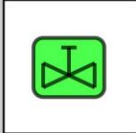
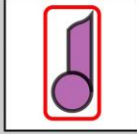
nur i30 LPG

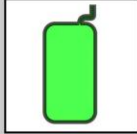





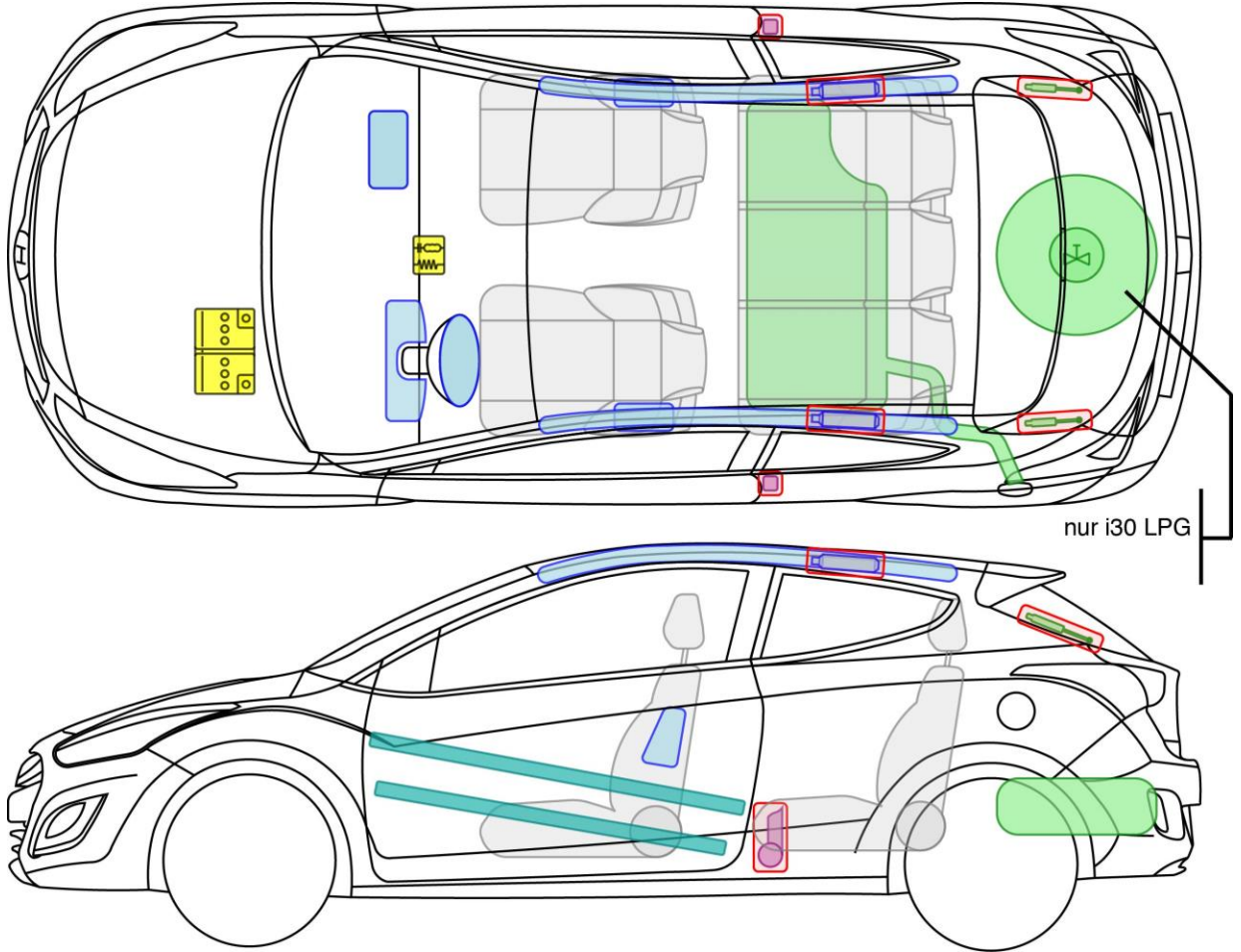

**Legende**

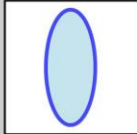
|   |                   |   |                            |   |                     |   |                            |
|---|-------------------|---|----------------------------|---|---------------------|---|----------------------------|
|  | Airbag            |  | Karosserie-<br>verstärkung |  | Steuergerät         |  | Gastank                    |
|  | Gas-<br>generator |  | Überroll-<br>schutz        |  | 12 V<br>Batterie    |  | Sicherheits-<br>ventil     |
|  | Gurt-<br>straffer |  | Gasdruck-<br>dämpfer       |  | Kraftstoff-<br>tank |  | Fußgänger-<br>schutzsystem |

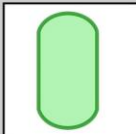
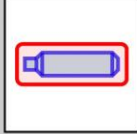
**i30**

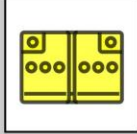

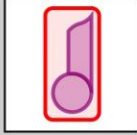
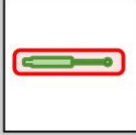
**Legende**

|   |                   |   |                            |   |                     |   |                            |
|---|-------------------|---|----------------------------|---|---------------------|---|----------------------------|
|  | Airbag            |  | Karosserie-<br>verstärkung |  | Steuergerät         |  | Gastank                    |
|  | Gas-<br>generator |  | Überroll-<br>schutz        |  | 12 V<br>Batterie    |  | Sicherheits-<br>ventil     |
|  | Gurt-<br>straffer |  | Gasdruck-<br>dämpfer       |  | Kraftstoff-<br>tank |  | Fußgänger-<br>schutzsystem |



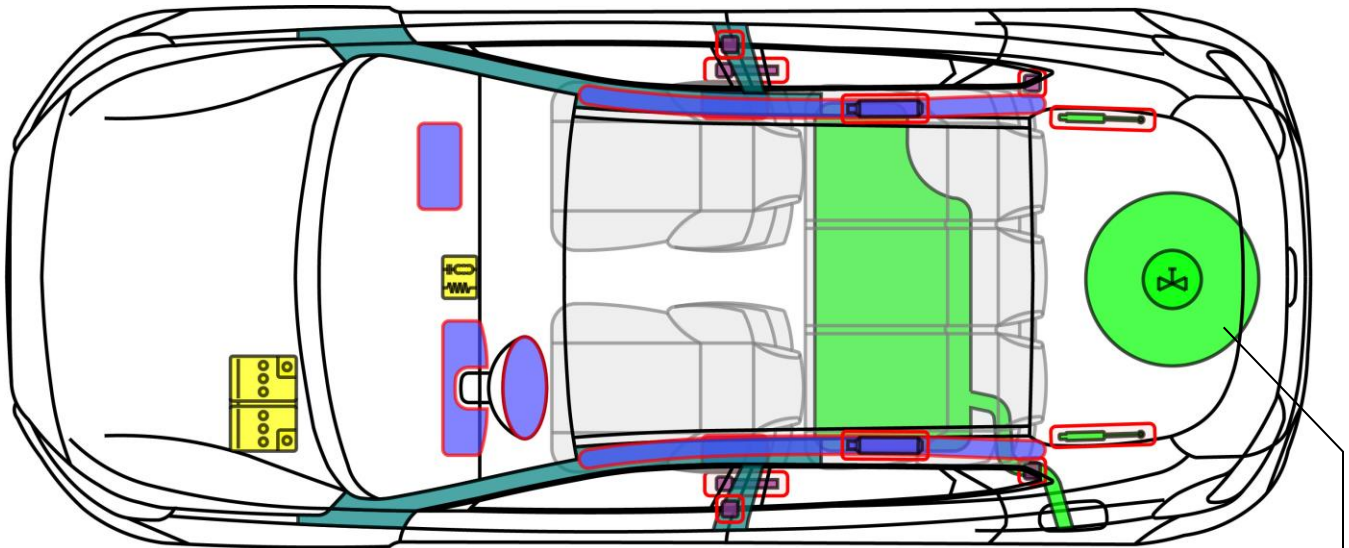

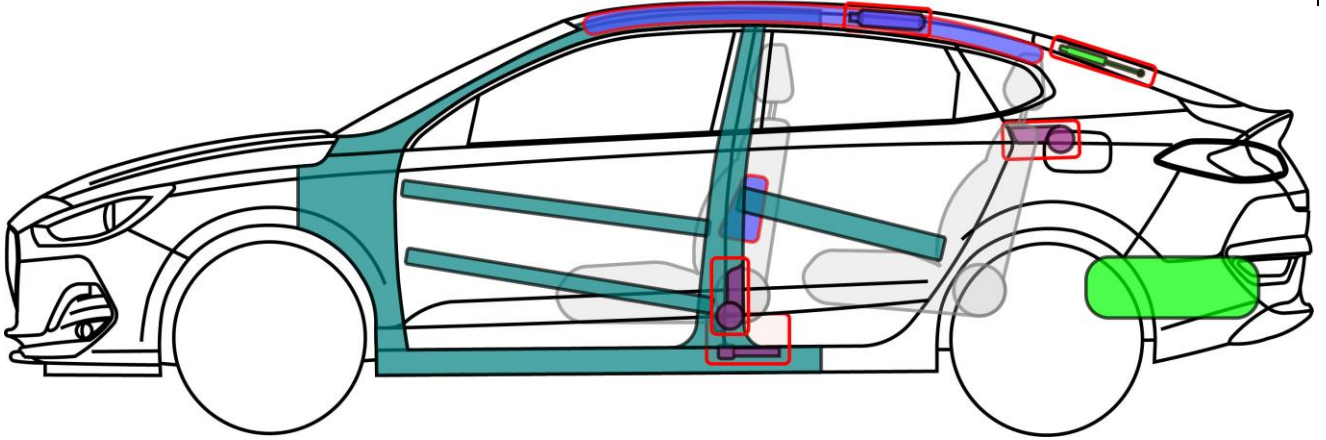

**i30 Coupe**



nur i30 LPG

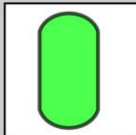
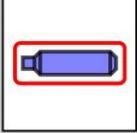

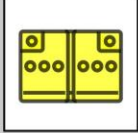
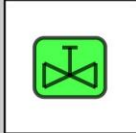
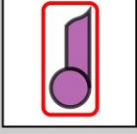
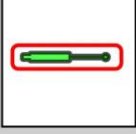
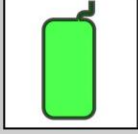
**Legende**

|   |                   |   |                            |   |                     |   |                            |
|---|-------------------|---|----------------------------|---|---------------------|---|----------------------------|
|  | Airbag            |  | Karosserie-<br>verstärkung |  | Steuergerät         |  | Gastank                    |
|  | Gas-<br>generator |  | Überroll-<br>schutz        |  | 12 V<br>Batterie    |  | Sicherheits-<br>ventil     |
|  | Gurt-<br>straffer |  | Gasdruck-<br>dämpfer       |  | Kraftstoff-<br>tank |  | Fußgänger-<br>schutzsystem |



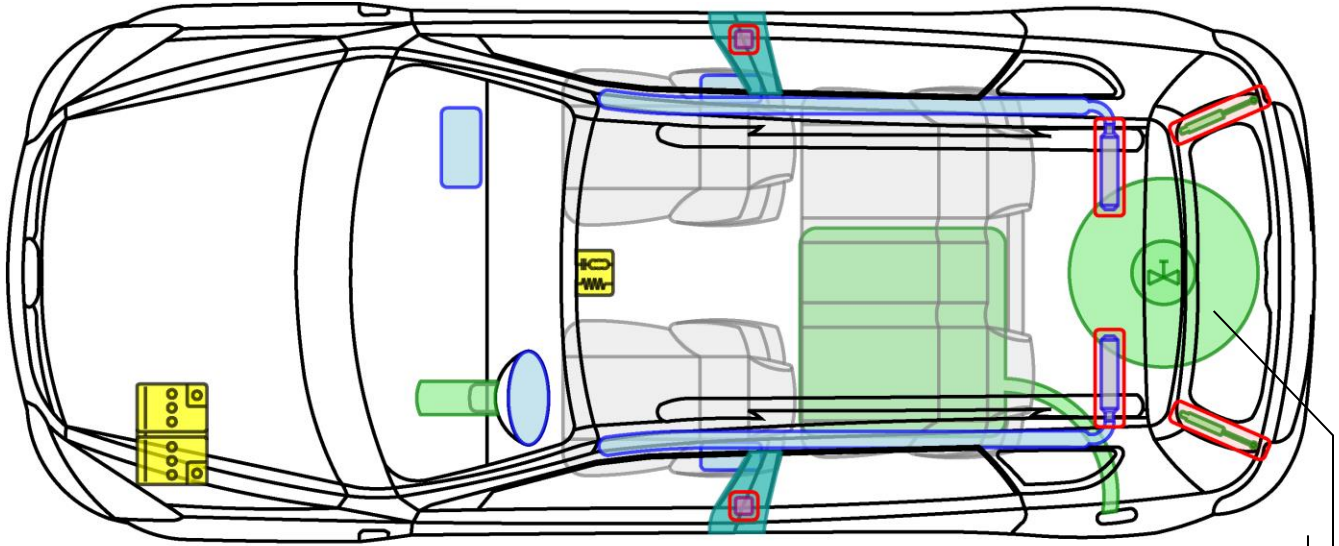



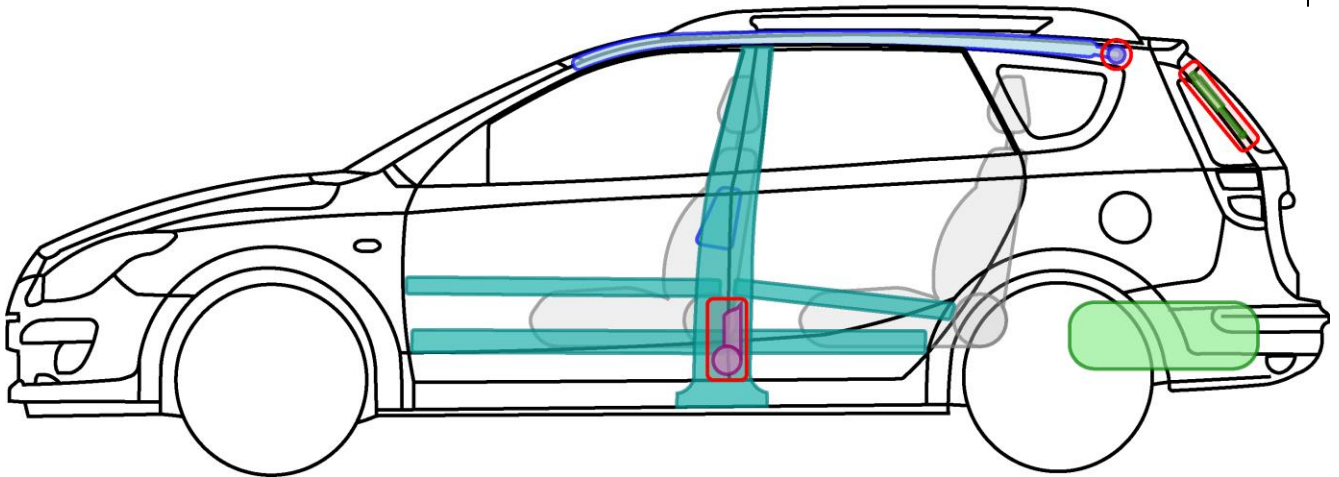

**i30 Fastback**

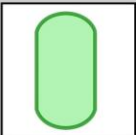
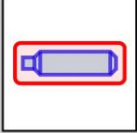

nur i30cw LPG

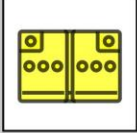

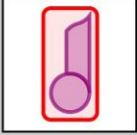
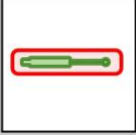





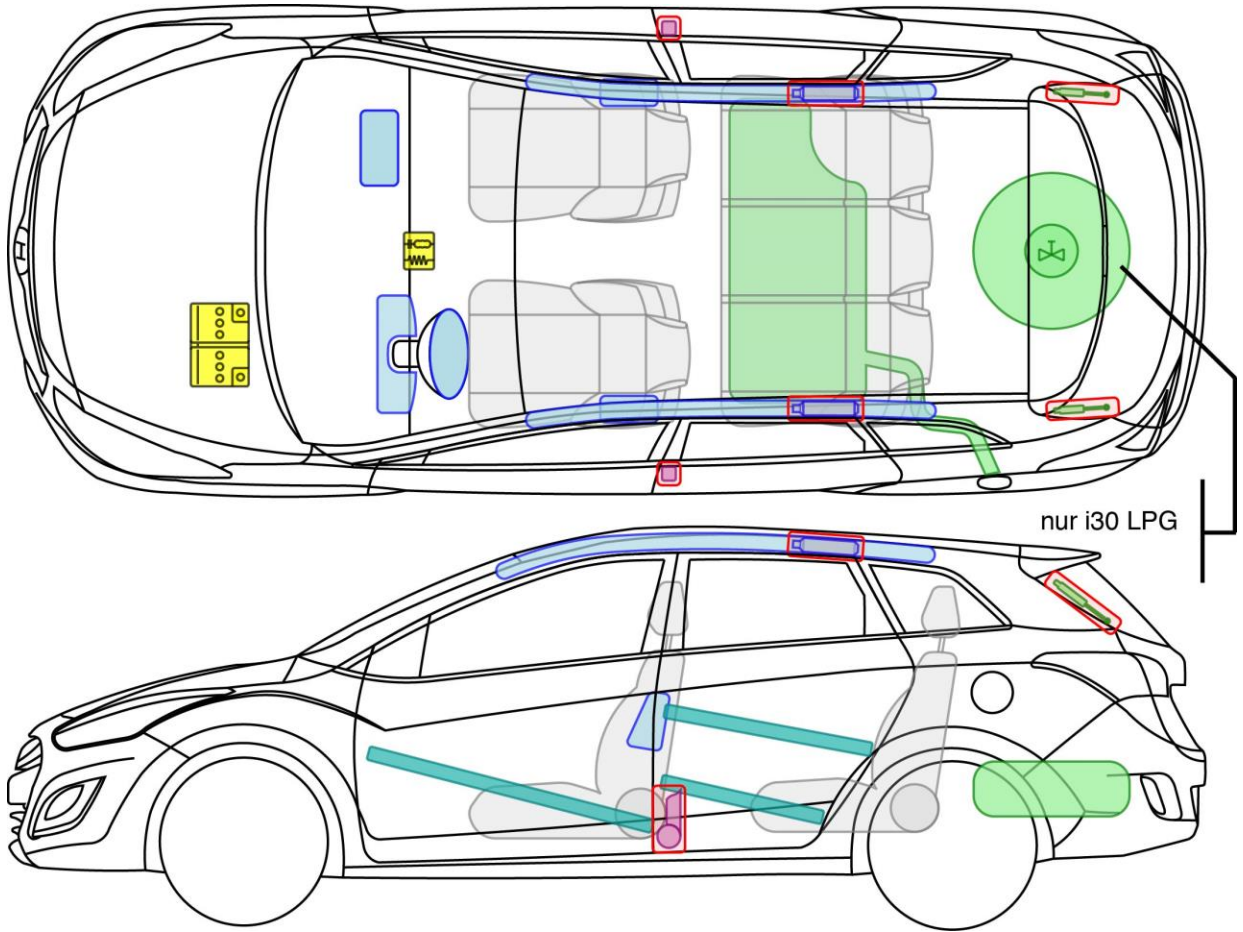

**Legende**

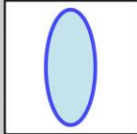
|   |                   |   |                            |   |                     |   |                            |
|---|-------------------|---|----------------------------|---|---------------------|---|----------------------------|
|  | Airbag            |  | Karosserie-<br>verstärkung |  | Steuergerät         |  | Gastank                    |
|  | Gas-<br>generator |  | Überroll-<br>schutz        |  | 12 V<br>Batterie    |  | Sicherheits-<br>ventil     |
|  | Gurt-<br>straffer |  | Gasdruck-<br>dämpfer       |  | Kraftstoff-<br>tank |  | Fußgänger-<br>schutzsystem |

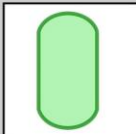
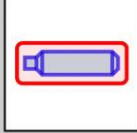
**i30cw**

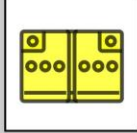

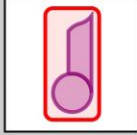
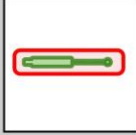
**Legende**





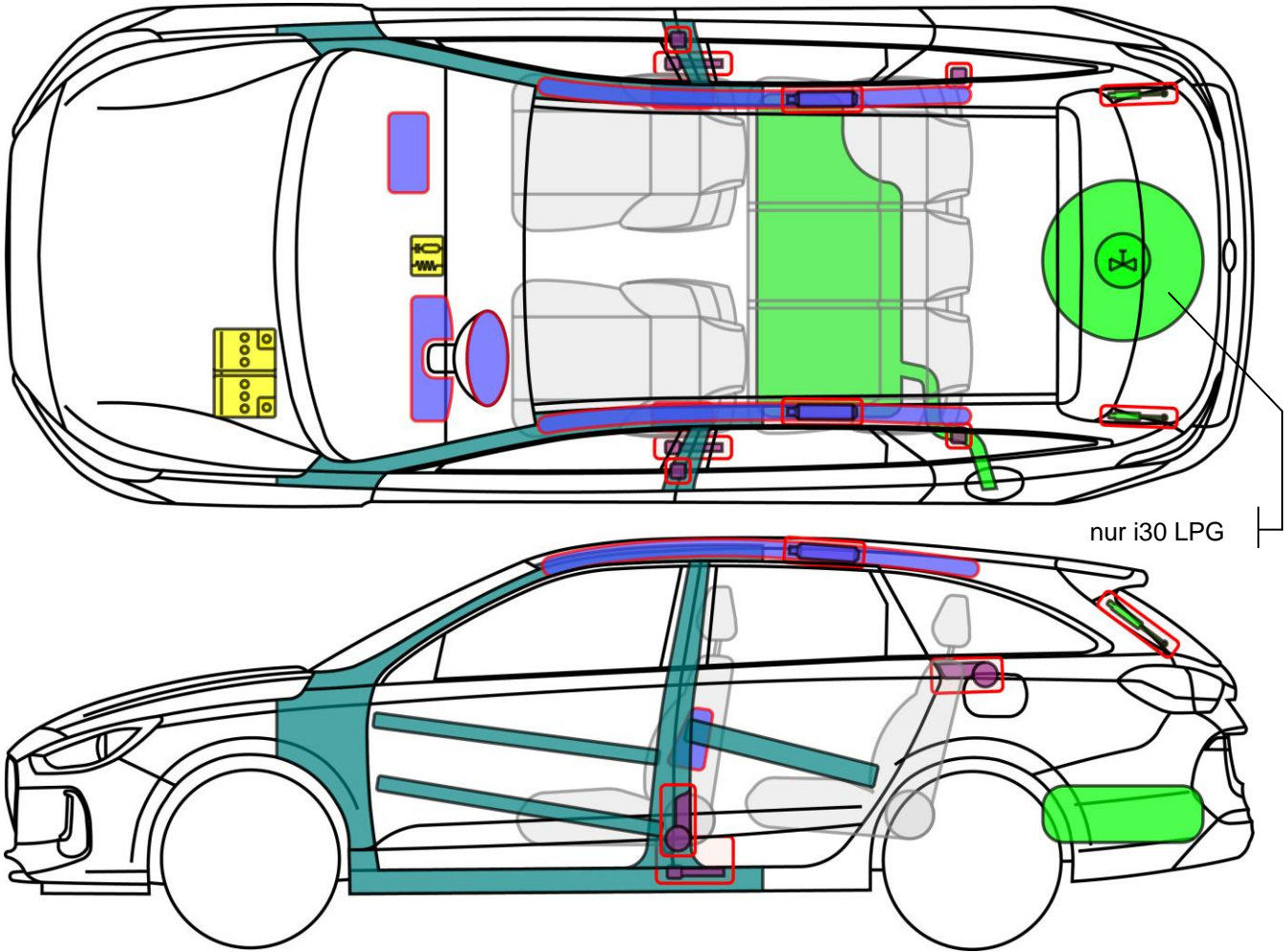



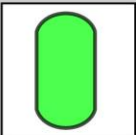
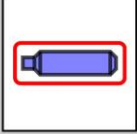

|   |                   |   |                            |   |                     |   |                            |
|---|-------------------|---|----------------------------|---|---------------------|---|----------------------------|
|  | Airbag            |  | Karosserie-<br>verstärkung |  | Steuergerät         |  | Gastank                    |
|  | Gas-<br>generator |  | Überroll-<br>schutz        |  | 12 V<br>Batterie    |  | Sicherheits-<br>ventil     |
|  | Gurt-<br>straffer |  | Gasdruck-<br>dämpfer       |  | Kraftstoff-<br>tank |  | Fußgänger-<br>schutzsystem |

**i30cw**

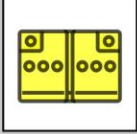

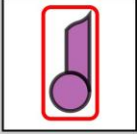
nur i30 LPG







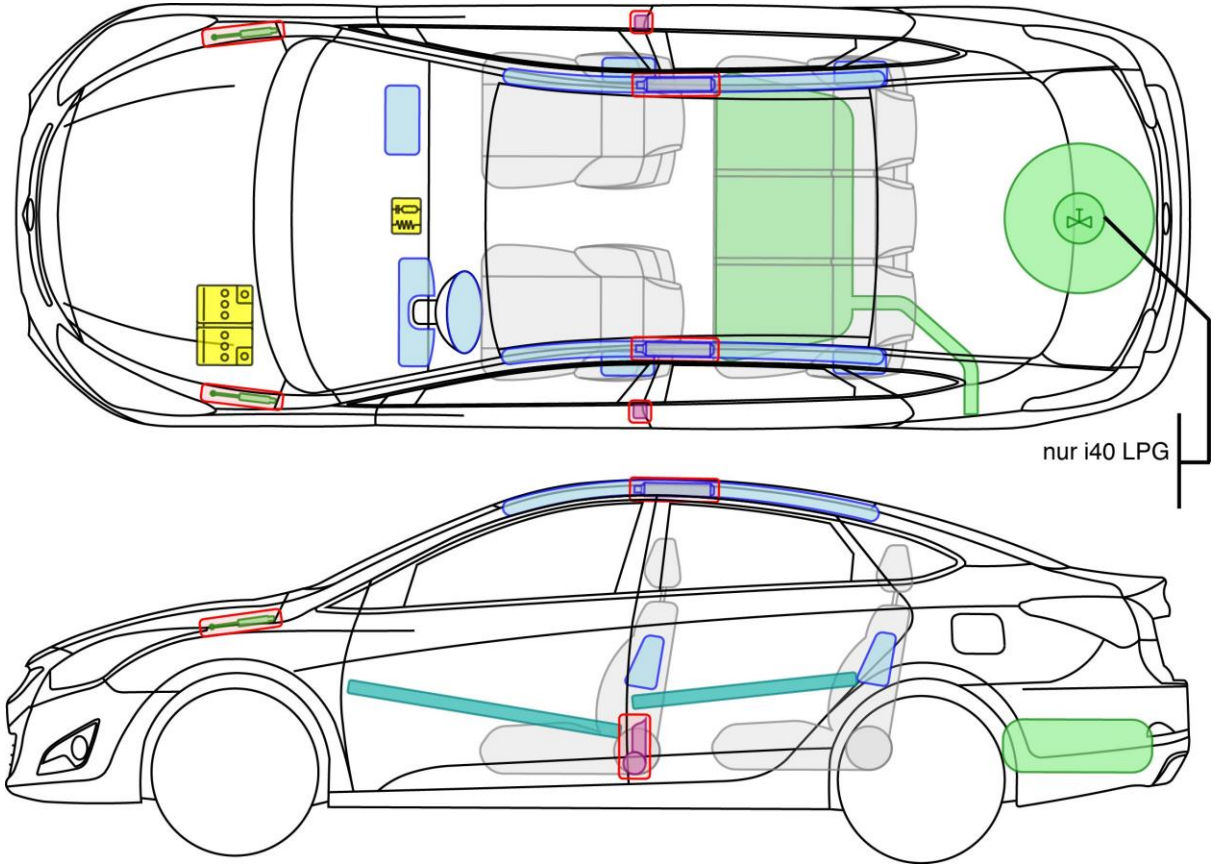

**Legende**

|   |                   |   |                            |   |                     |   |                            |
|---|-------------------|---|----------------------------|---|---------------------|---|----------------------------|
|  | Airbag            |  | Karosserie-<br>verstärkung |  | Steuergerät         |  | Gastank                    |
|  | Gas-<br>generator |  | Überroll-<br>schutz        |  | 12 V<br>Batterie    |  | Sicherheits-<br>ventil     |
|  | Gurt-<br>straffer |  | Gasdruck-<br>dämpfer       |  | Kraftstoff-<br>tank |  | Fußgänger-<br>schutzsystem |

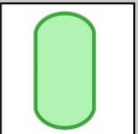
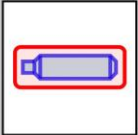
**i30cw**

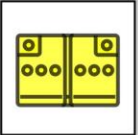

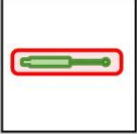





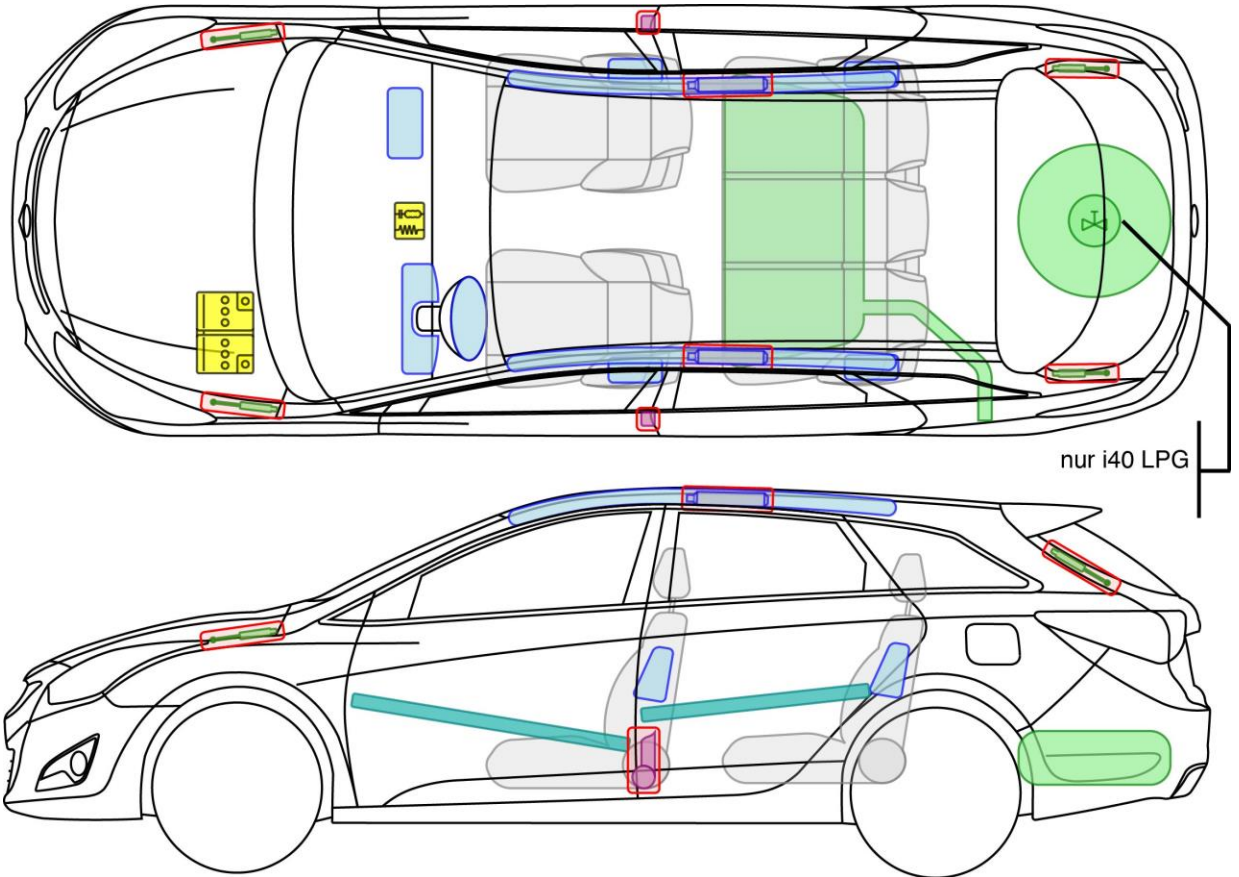

**Legende**

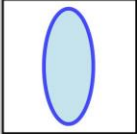
|   |                   |   |                            |   |                     |   |                            |
|---|-------------------|---|----------------------------|---|---------------------|---|----------------------------|
|  | Airbag            |  | Karosserie-<br>verstärkung |  | Steuergerät         |  | Gastank                    |
|  | Gas-<br>generator |  | Überroll-<br>schutz        |  | 12 V<br>Batterie    |  | Sicherheits-<br>ventil     |
|  | Gurt-<br>straffer |  | Gasdruck-<br>dämpfer       |  | Kraftstoff-<br>tank |  | Fußgänger-<br>schutzsystem |

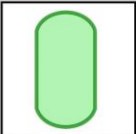
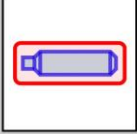
**i40**

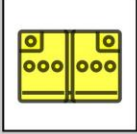

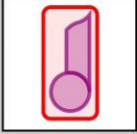
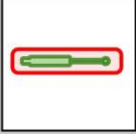
**Legende**







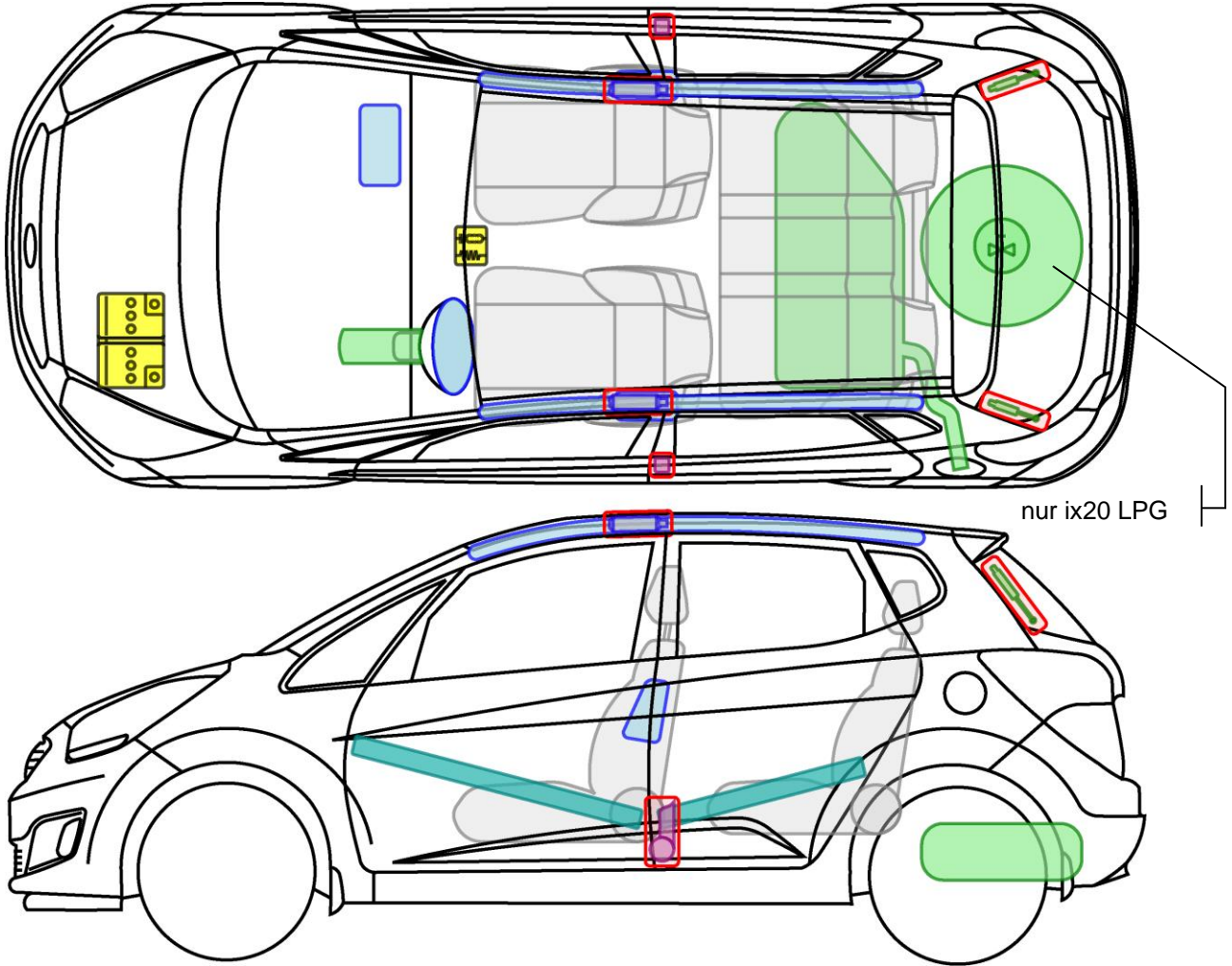

|   |                   |   |                            |   |                     |   |                            |
|---|-------------------|---|----------------------------|---|---------------------|---|----------------------------|
|  | Airbag            |  | Karosserie-<br>verstärkung |  | Steuergerät         |  | Gastank                    |
|  | Gas-<br>generator |  | Überroll-<br>schutz        |  | 12 V<br>Batterie    |  | Sicherheits-<br>ventil     |
|  | Gurt-<br>straffer |  | Gasdruck-<br>dämpfer       |  | Kraftstoff-<br>tank |  | Fußgänger-<br>schutzsystem |

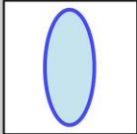
**i40cw**

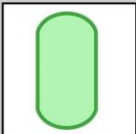
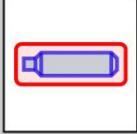

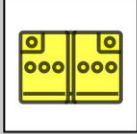

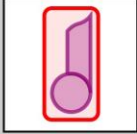
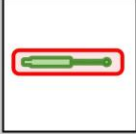





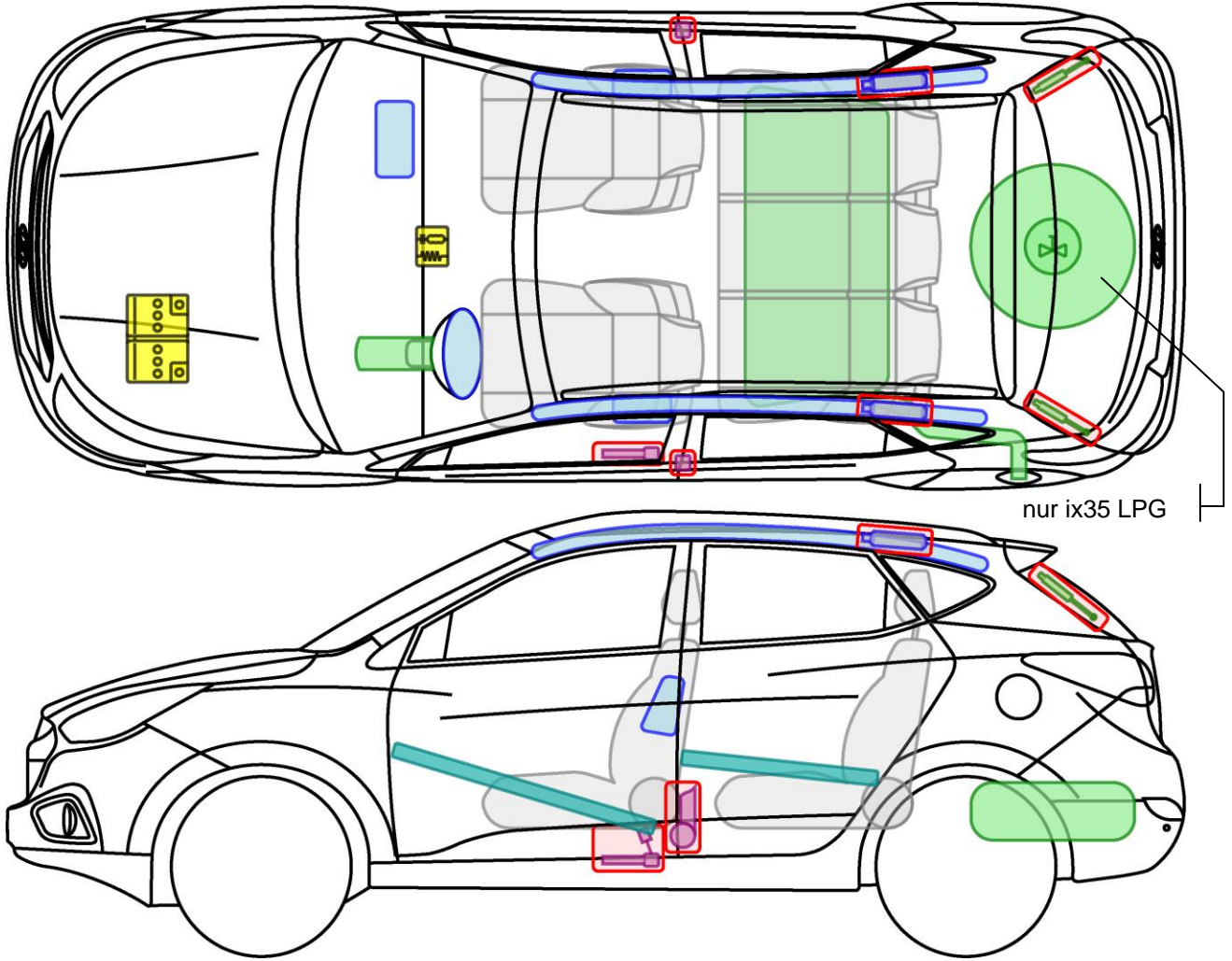



**Legende**

|   |                   |   |                            |   |                     |   |                            |
|---|-------------------|---|----------------------------|---|---------------------|---|----------------------------|
|  | Airbag            |  | Karosserie-<br>verstärkung |  | Steuergerät         |  | Gastank                    |
|  | Gas-<br>generator |  | Überroll-<br>schutz        |  | 12 V<br>Batterie    |  | Sicherheits-<br>ventil     |
|  | Gurt-<br>straffer |  | Gasdruck-<br>dämpfer       |  | Kraftstoff-<br>tank |  | Fußgänger-<br>schutzsystem |

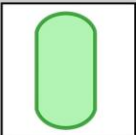
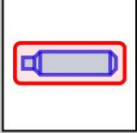
**ix20**

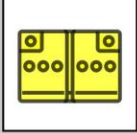

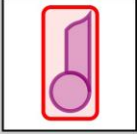
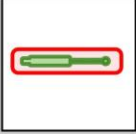





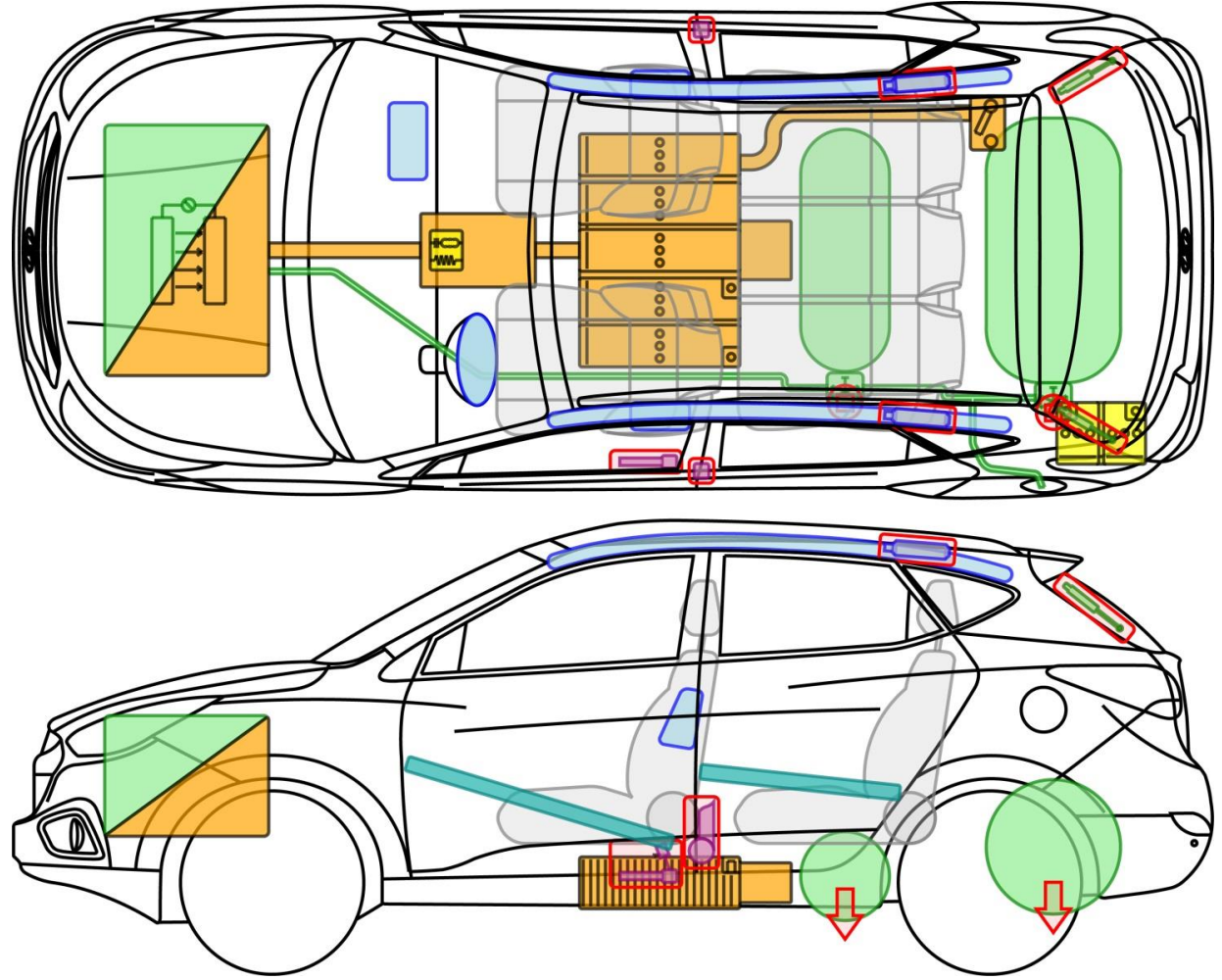

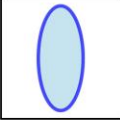

**Legende**

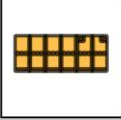
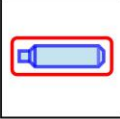
|   |                   |   |                            |   |                     |   |                            |
|---|-------------------|---|----------------------------|---|---------------------|---|----------------------------|
|  | Airbag            |  | Karosserie-<br>verstärkung |  | Steuergerät         |  | Gastank                    |
|  | Gas-<br>generator |  | Überroll-<br>schutz        |  | 12 V<br>Batterie    |  | Sicherheits-<br>ventil     |
|  | Gurt-<br>straffer |  | Gasdruck-<br>dämpfer       |  | Kraftstoff-<br>tank |  | Fußgänger-<br>schutzsystem |

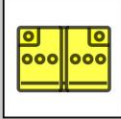
**ix35**

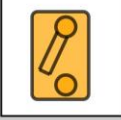

**Legende**

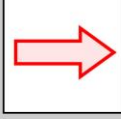
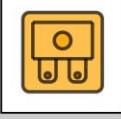
|   |                      |   |                            |   |                     |  |                                      |
|---|----------------------|---|----------------------------|---|---------------------|--|--------------------------------------|
|  | Airbag               |  | Karosserie-<br>verstärkung |  | Steuergerät         |  | Hochvolt-<br>batterie                |
|  | Gas-<br>generator    |  | Überroll-<br>schutz        |  | 12 V<br>Batterie    |  | Hochvolt-<br>leitung/<br>-komponente |
|  | Gurt-<br>straffer    |  | Gasdruck-<br>dämpfer       |  | Kraftstoff-<br>tank |  | Notfalltren-<br>stelle               |
|  | Brennstoff-<br>zelle |  | Sicherheits-<br>ventil     |  | Abblas-<br>richtung |  | Sicherungs-<br>kasten                |

**ix35 FCEV**



## Allgemeine Hinweise

- Fahrzeug mit elektrischem Brennstoffzellen-System.  
**Druckwasserstoffspeicherung.**
- Initialer Sicherheitsabstand: **50 m**
- Bereich der **Wasserstoff-Abblaseeinrichtung** freihalten (rote Pfeile)
- Hochvoltkomponenten sind mit Warnaufklebern gekennzeichnet.
- Hochvoltkabel verfügen über eine orangefarbene Isolierung.
- Wasserstofftanks verfügen über elektromagnetische Absperrventile, manuelles Schließen nicht möglich.
- Hochvolt- und Wasserstoffsystem werden bei Unfällen mit Airbagauslösung i.d.R. automatisch abgeschaltet.
- Fahrzeug wie angegeben deaktivieren.

## Fahrzeug immobilisieren und deaktivieren

- Gangwahlhebel in Stellung „P“ bringen
- Feststellbremse betätigen.

- Bei eingeschalteter Zündung:
  1. Bremspedal nicht betätigen
  2. Start-Stop Knopf einmal betätigen

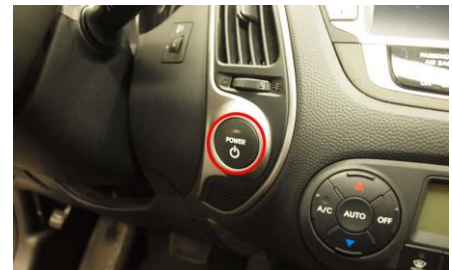

- 12 Volt Batterie abklemmen









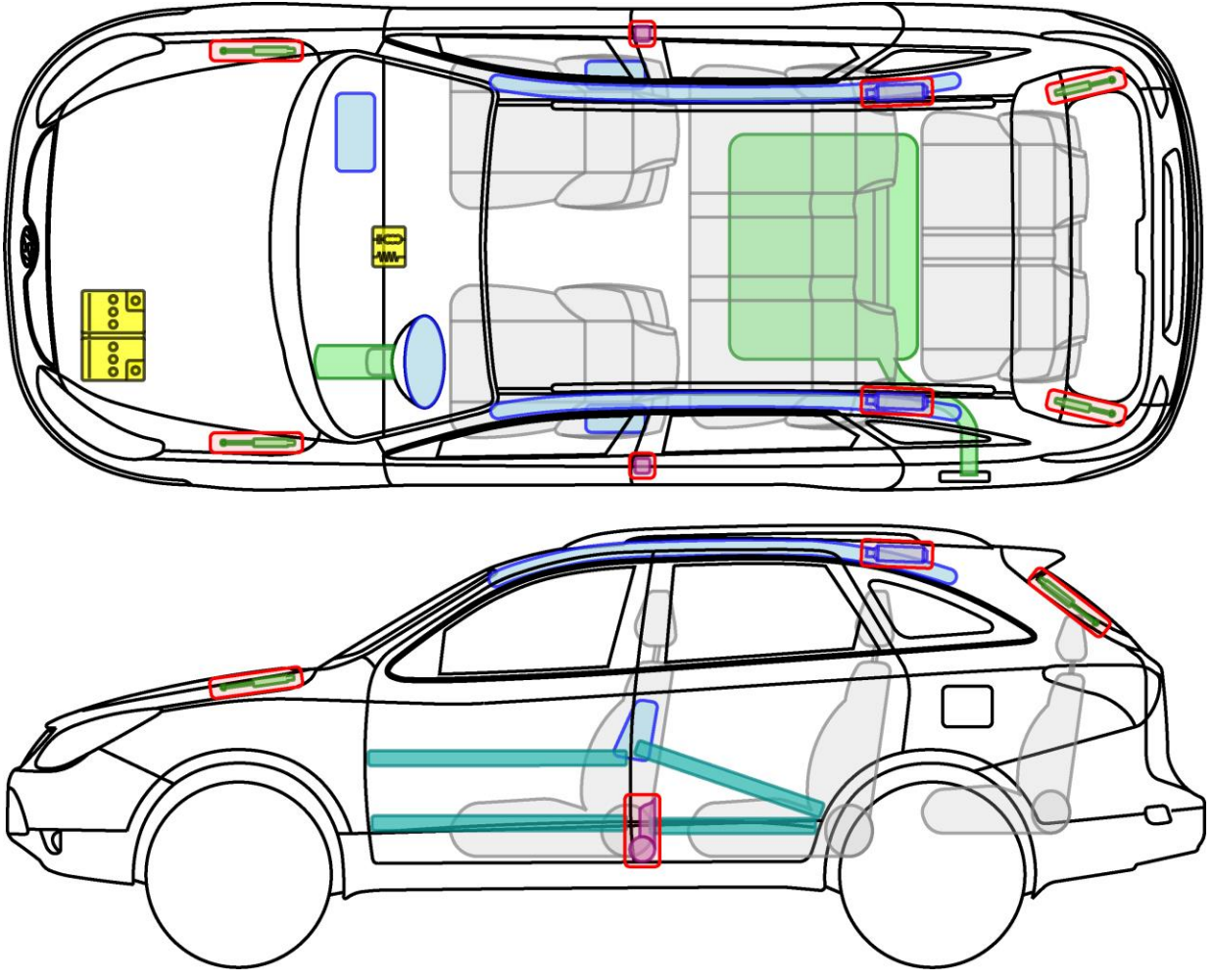

- Service Disconnect Stecker entfernen (isolierende Schutzhandschuhe bis 1000 V erforderlich)

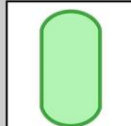
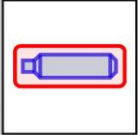

ix35 FCEV

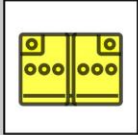

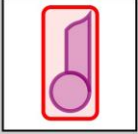
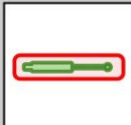





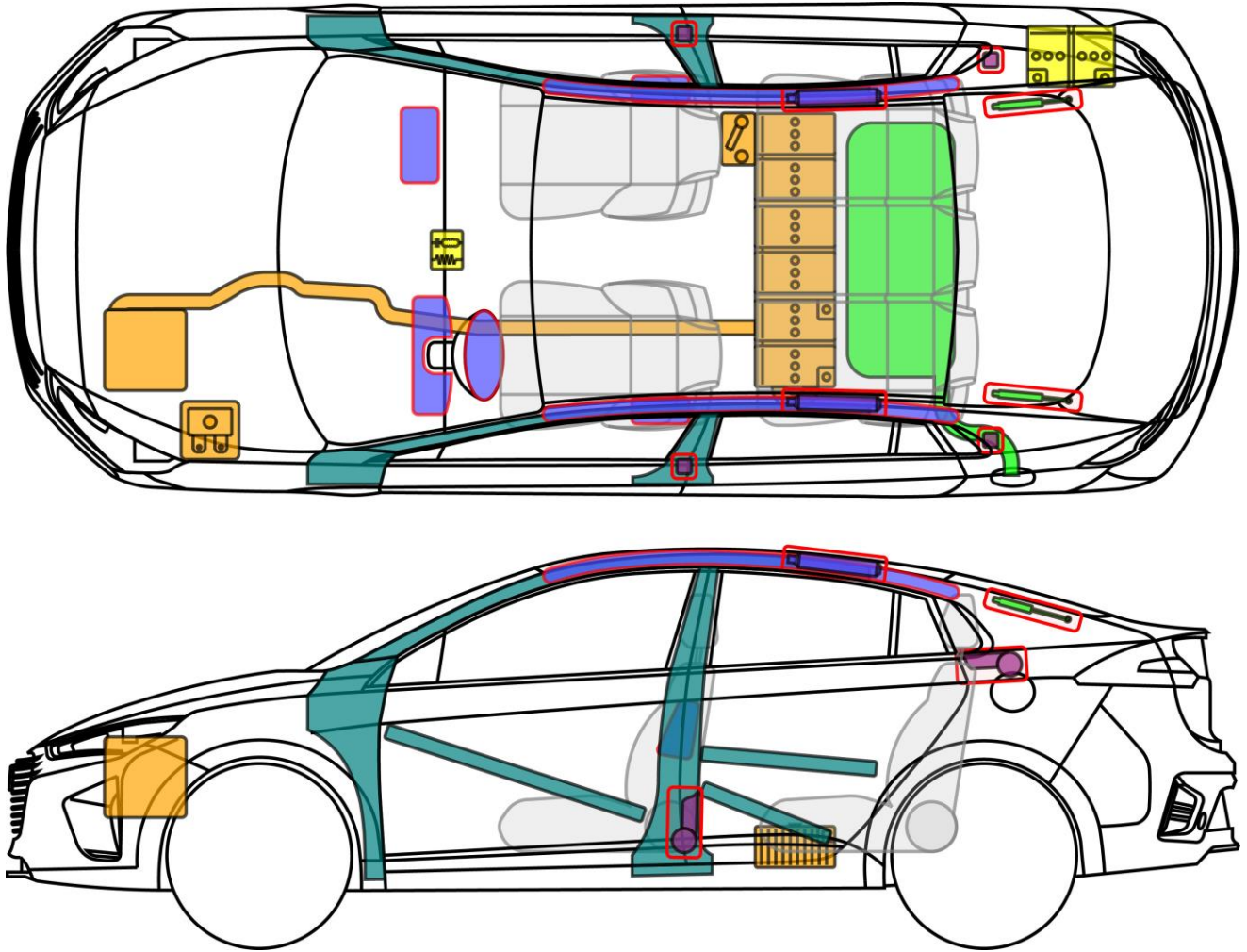

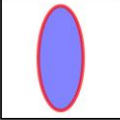
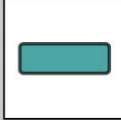

**Legende**

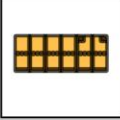
|   |                   |   |                            |   |                     |   |                            |
|---|-------------------|---|----------------------------|---|---------------------|---|----------------------------|
|  | Airbag            |  | Karosserie-<br>verstärkung |  | Steuergerät         |  | Gastank                    |
|  | Gas-<br>generator |  | Überroll-<br>schutz        |  | 12 V<br>Batterie    |  | Sicherheits-<br>ventil     |
|  | Gurt-<br>straffer |  | Gasdruck-<br>dämpfer       |  | Kraftstoff-<br>tank |  | Fußgänger-<br>schutzsystem |

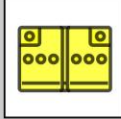
**ix55**

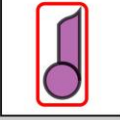

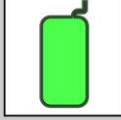
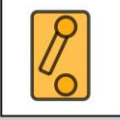

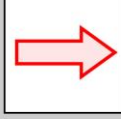
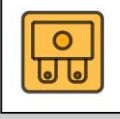



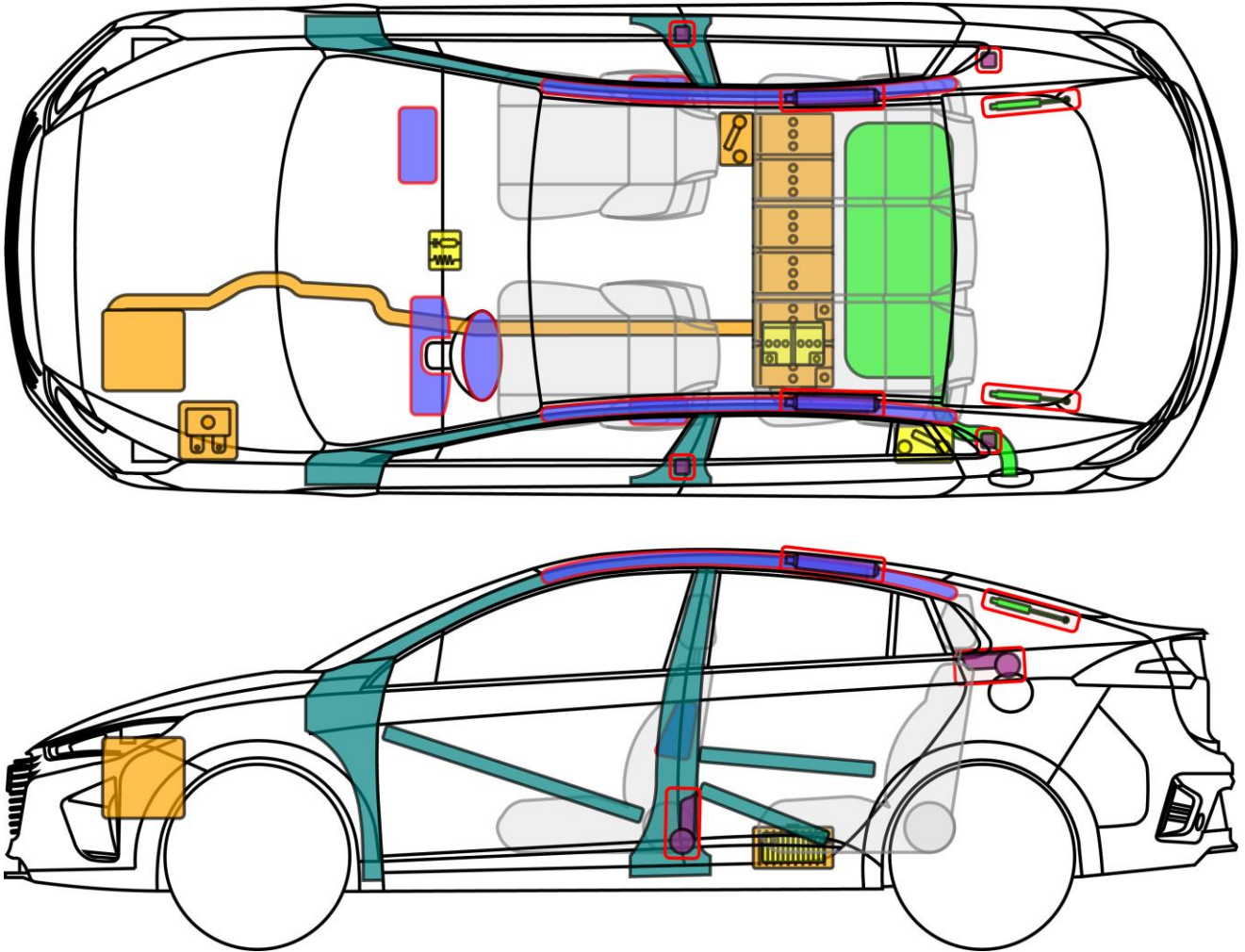

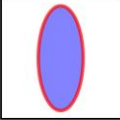
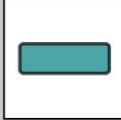

**Legende**

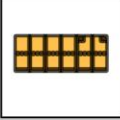
|   |                      |   |                            |   |                     |  |                                      |
|---|----------------------|---|----------------------------|---|---------------------|--|--------------------------------------|
|  | Airbag               |  | Karosserie-<br>verstärkung |  | Steuergerät         |  | Hochvolt-<br>batterie                |
|  | Gas-<br>generator    |  | Überroll-<br>schutz        |  | 12 V<br>Batterie    |  | Hochvolt-<br>leitung/<br>-komponente |
|  | Gurt-<br>straffer    |  | Gasdruck-<br>dämpfer       |  | Kraftstoff-<br>tank |  | Notfalltren-<br>stelle               |
|  | Brennstoff-<br>zelle |  | Sicherheits-<br>ventil     |  | Abblas-<br>richtung |  | Sicherungs-<br>kasten                |

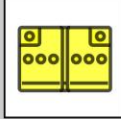
**Ioniq Hybrid**

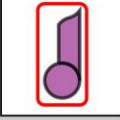

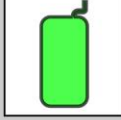
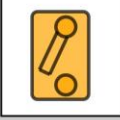
**Legende**

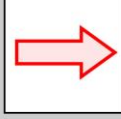
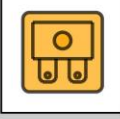
|   |                      |   |                            |   |                     |  |                                      |
|---|----------------------|---|----------------------------|---|---------------------|--|--------------------------------------|
|  | Airbag               |  | Karosserie-<br>verstärkung |  | Steuergerät         |  | Hochvolt-<br>batterie                |
|  | Gas-<br>generator    |  | Überroll-<br>schutz        |  | 12 V<br>Batterie    |  | Hochvolt-<br>leitung/<br>-komponente |
|  | Gurt-<br>straffer    |  | Gasdruck-<br>dämpfer       |  | Kraftstoff-<br>tank |  | Notfalltren-<br>stelle               |
|  | Brennstoff-<br>zelle |  | Sicherheits-<br>ventil     |  | Abblas-<br>richtung |  | Sicherungs-<br>kasten                |

**Ioniq Hybrid**

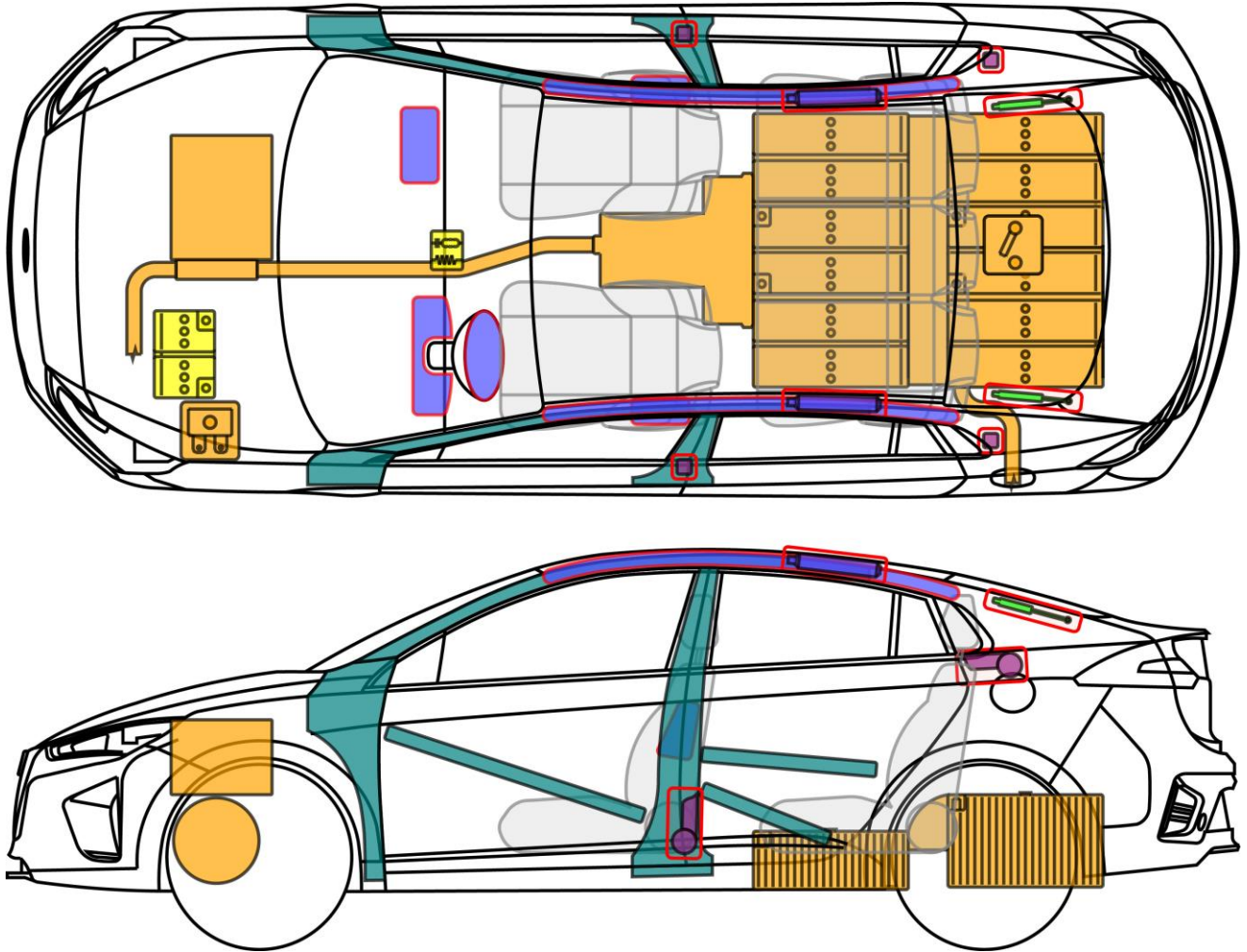

**Legende**







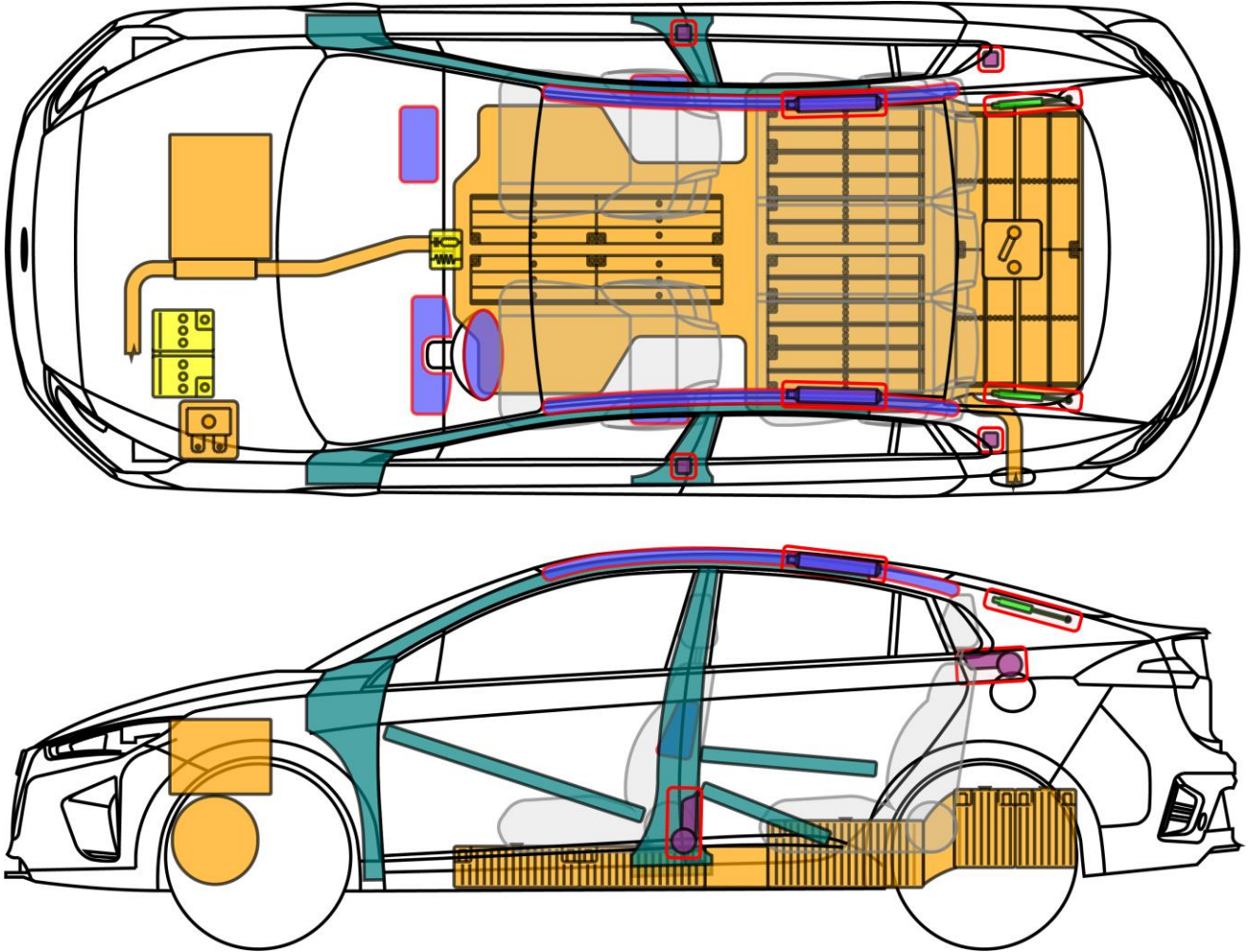

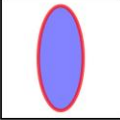
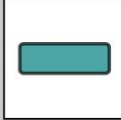

|  |                  |  |                        |  |                 |  |                              |
|--|------------------|--|------------------------|--|-----------------|--|------------------------------|
|  | Airbag           |  | Karosserie-verstärkung |  | Steuergerät     |  | Hochvolt-batterie            |
|  | Gas-generator    |  | Überroll-schutz        |  | 12 V Batterie   |  | Hochvolt-leitung/-komponente |
|  | Gurt-straffer    |  | Gasdruck-dämpfer       |  | Kraftstoff-tank |  | Notfalltrennstelle           |
|  | Brennstoff-zelle |  | Sicherheits-ventil     |  | Abblas-richtung |  | Sicherungs-kasten            |

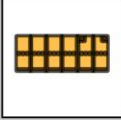
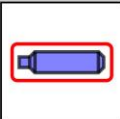
**Ioniq Elektro**

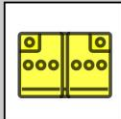

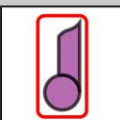
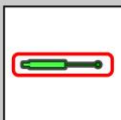
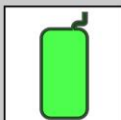
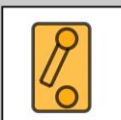

**Legende**

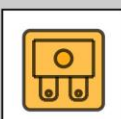
|   |                      |   |                            |   |                     |  |                                      |
|---|----------------------|---|----------------------------|---|---------------------|--|--------------------------------------|
|  | Airbag               |  | Karosserie-<br>verstärkung |  | Steuergerät         |  | Hochvolt-<br>batterie                |
|  | Gas-<br>generator    |  | Überroll-<br>schutz        |  | 12 V<br>Batterie    |  | Hochvolt-<br>leitung/<br>-komponente |
|  | Gurt-<br>straffer    |  | Gasdruck-<br>dämpfer       |  | Kraftstoff-<br>tank |  | Notfalltren-<br>stelle               |
|  | Brennstoff-<br>zelle |  | Sicherheits-<br>ventil     |  | Abblas-<br>richtung |  | Sicherungs-<br>kasten                |

**Ioniq Elektro**



## Allgemeine Hinweise

- Bei Unfällen mit Airbag und/oder Gurtstrafferauslösung wird der Fahrzeugantrieb automatisch deaktiviert. Die Rückhaltesysteme sind weiterhin aktiv.
- Die Zeit bis zur vollständigen Deaktivierung des Antriebs beträgt 5 Minuten nach Durchführung der Deaktivierungsschritte.
- **Schutzausrüstung erforderlich (Isolierende Handschuhe bis 1000 V, Gesichtsschutz).**

## Fahrzeug immobilisieren und deaktivieren

- Räder verkeilen, Feststellbremse betätigen und Taste P (Parken) drücken.

### Methode 1:

1. Prüfen ob das Hochvoltsystem eingeschaltet ist. Symbol:  .
2. Ist das System aktiv, Start-Stopp Knopf einmal betätigen.

Das Symbol darf nicht mehr leuchten!

3. Massekabel der 12 Volt Batterie abklemmen.

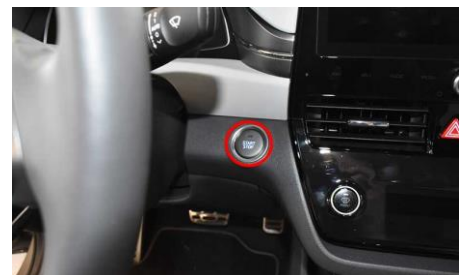



## Fahrzeug immobilisieren und deaktivieren

4. Service Disconnect Stecker wie dargestellt entfernen (isolierende Schutzhandschuhe bis 1000 V erforderlich).



Ist der Start/Stop-Knopf nicht zugänglich,  
Methode 2 Folgen!

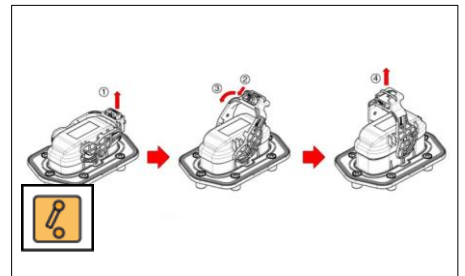

**Kona Elektro**

- **Kann die 12 Volt Batterie nicht abgeklemmt werden, sind die Rückhaltesysteme weiterhin aktiv!**
- **Achtung: Die Spannung im Hochvoltsystem ist erst nach ca. 5 min. vollständig deaktiviert!**



## Fahrzeug immobilisieren und deaktivieren

### Methode 2:

1. Dargestellte Sicherungen aus dem Sicherungskasten entfernen.
2. Massekabel der 12 Volt Batterie abklemmen.
3. Service Disconnect Stecker wie dargestellt entfernen (isolierende Schutzhandschuhe bis 1000 V erforderlich).





## Fahrzeug immobilisieren und deaktivieren



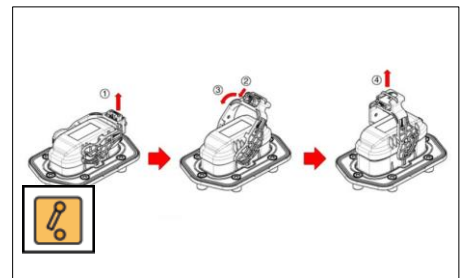



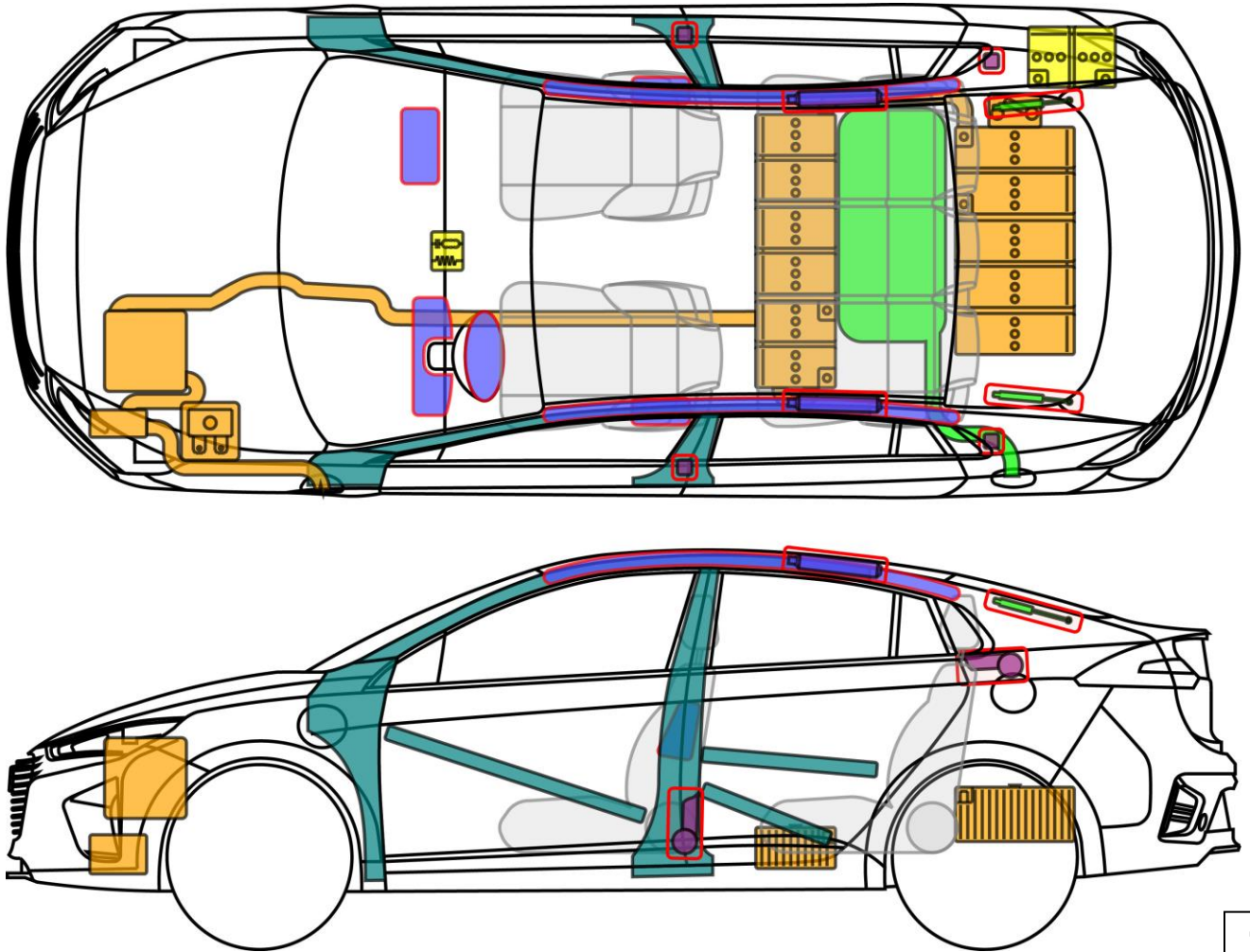

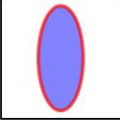
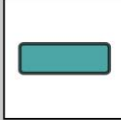

Service Disconnect Stecker wie dargestellt entfernen (isolierende Schutzhandschuhe bis 1000 V erforderlich).

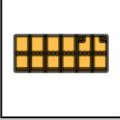
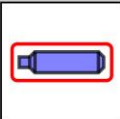

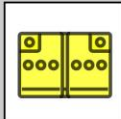
- **Kann die 12 Volt Batterie nicht abgeklemmt werden, sind die Rückhaltesysteme weiterhin aktiv!**
- **Achtung: Die Spannung im Hochvoltsystem ist erst nach ca. 5 min. vollständig deaktiviert!**

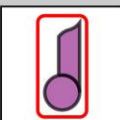
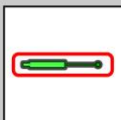
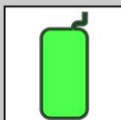
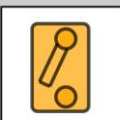

### Legende

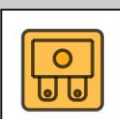
|   |                      |   |                            |   |                     |  |                                      |
|---|----------------------|---|----------------------------|---|---------------------|--|--------------------------------------|
|  | Airbag               |  | Karosserie-<br>verstärkung |  | Steuergerät         |  | Hochvolt-<br>batterie                |
|  | Gas-<br>generator    |  | Überroll-<br>schutz        |  | 12 V<br>Batterie    |  | Hochvolt-<br>leitung/<br>-komponente |
|  | Gurt-<br>straffer    |  | Gasdruck-<br>dämpfer       |  | Kraftstoff-<br>tank |  | Notfalltren-<br>stelle               |
|  | Brennstoff-<br>zelle |  | Sicherheits-<br>ventil     |  | Abblas-<br>richtung |  | Sicherungs-<br>kasten                |



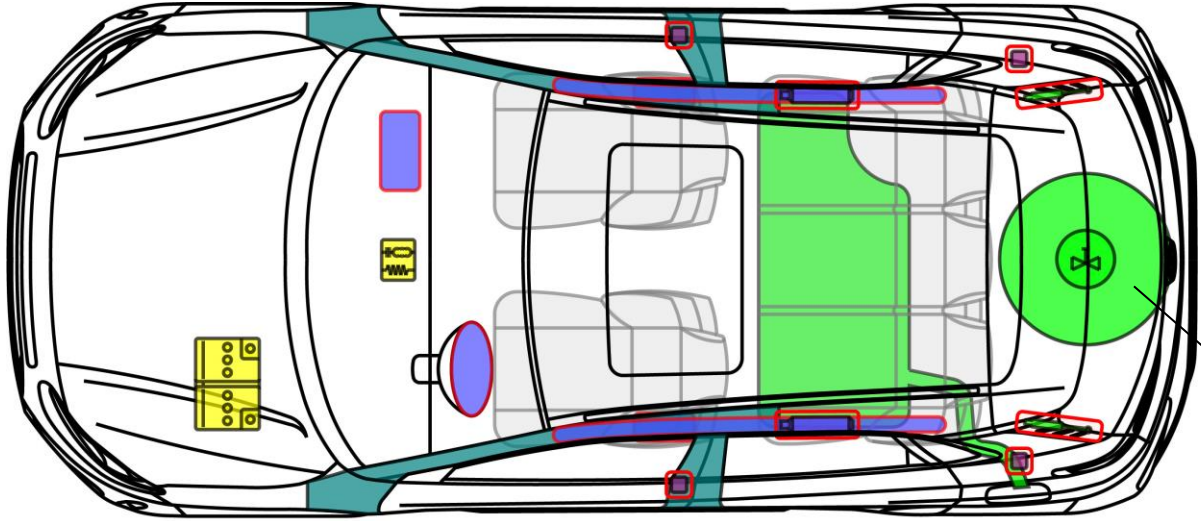



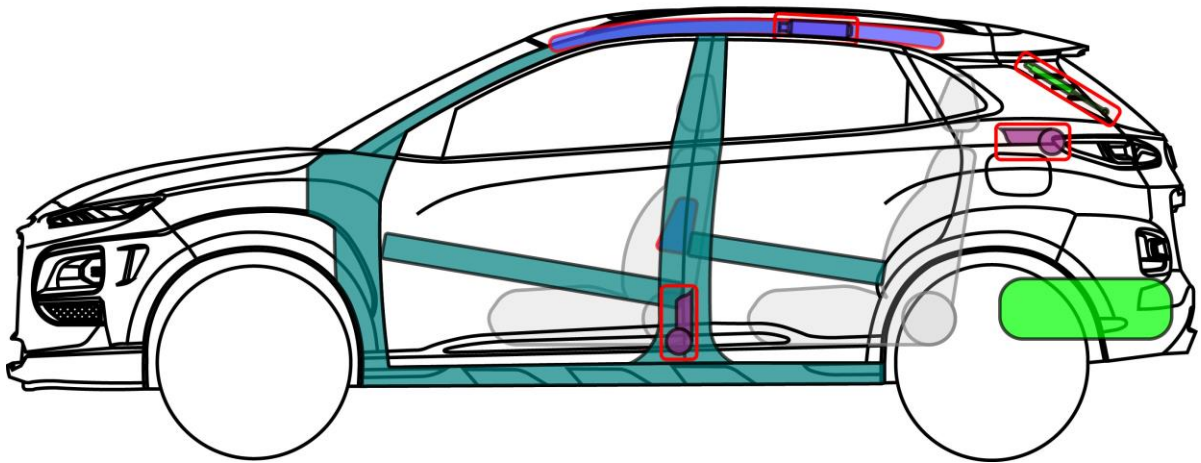

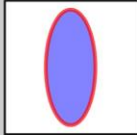
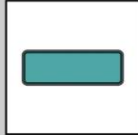

**Ioniq Plug-in Hybrid**

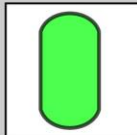
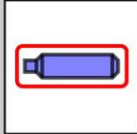

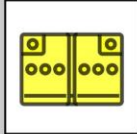
Nur Kona LPG

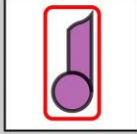

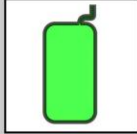





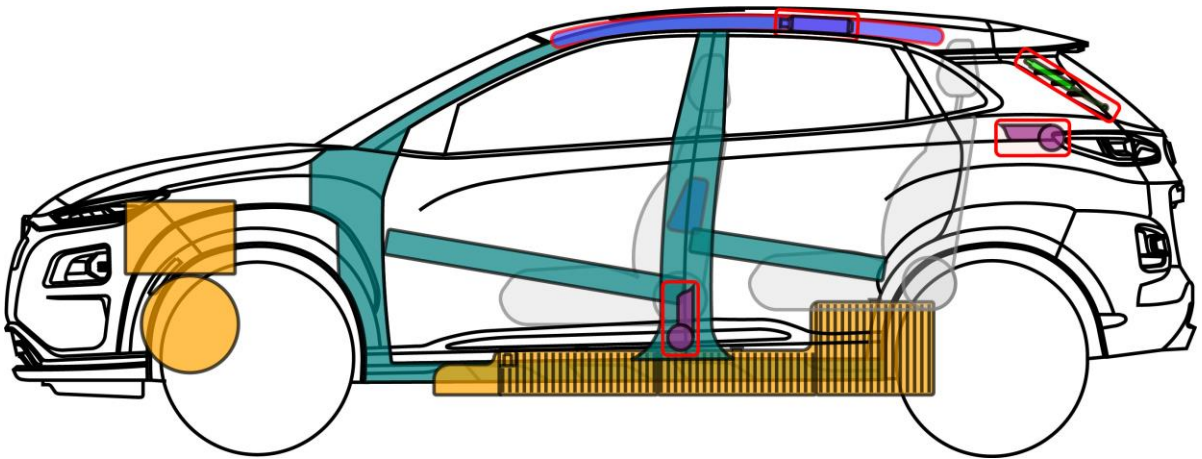
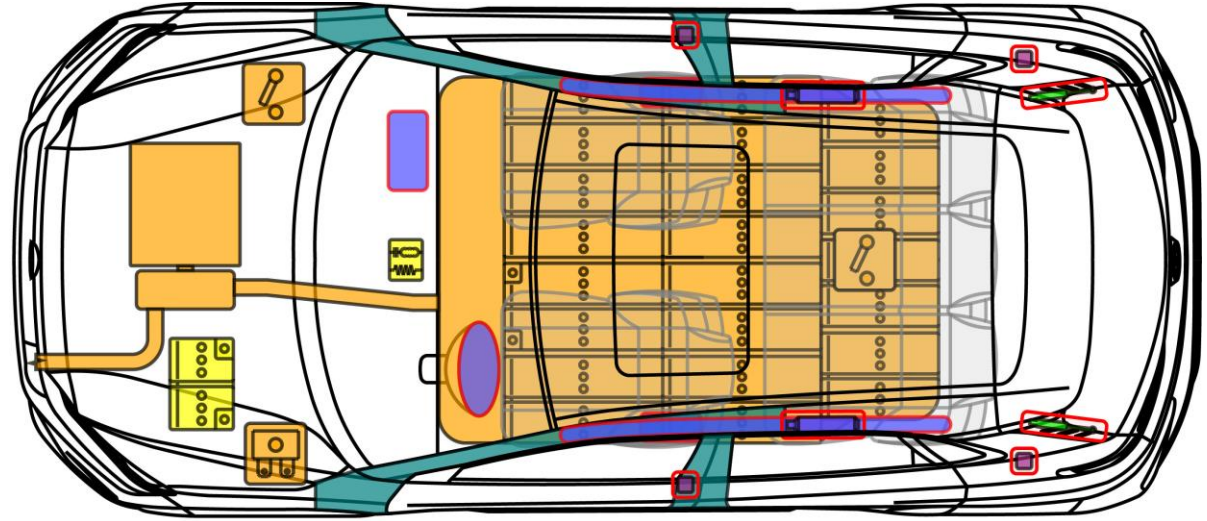

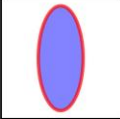
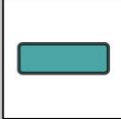

**Legende**

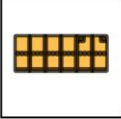
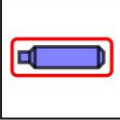
|   |                   |   |                            |   |                     |   |                            |
|---|-------------------|---|----------------------------|---|---------------------|---|----------------------------|
|  | Airbag            |  | Karosserie-<br>verstärkung |  | Steuergerät         |  | Gastank                    |
|  | Gas-<br>generator |  | Überroll-<br>schutz        |  | 12 V<br>Batterie    |  | Sicherheits-<br>ventil     |
|  | Gurt-<br>straffer |  | Gasdruck-<br>dämpfer       |  | Kraftstoff-<br>tank |  | Fußgänger-<br>schutzsystem |

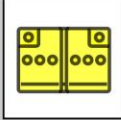
**Kona**

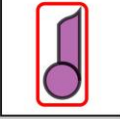

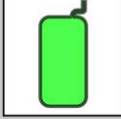
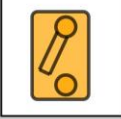
**Legende**

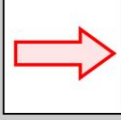
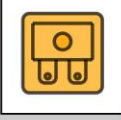
|   |                      |   |                            |   |                     |  |                                      |
|---|----------------------|---|----------------------------|---|---------------------|--|--------------------------------------|
|  | Airbag               |  | Karosserie-<br>verstärkung |  | Steuergerät         |  | Hochvolt-<br>batterie                |
|  | Gas-<br>generator    |  | Überroll-<br>schutz        |  | 12 V<br>Batterie    |  | Hochvolt-<br>leitung/<br>-komponente |
|  | Gurt-<br>straffer    |  | Gasdruck-<br>dämpfer       |  | Kraftstoff-<br>tank |  | Notfalltren-<br>stelle               |
|  | Brennstoff-<br>zelle |  | Sicherheits-<br>ventil     |  | Abblas-<br>richtung |  | Sicherungs-<br>kasten                |

**Kona Elektro**





## Allgemeine Hinweise

- Bei Unfällen mit Airbag und/oder Gurtstrafferauslösung wird der Fahrzeugantrieb automatisch deaktiviert. Die Rückhaltesysteme sind weiterhin aktiv.
- Die Zeit bis zur vollständigen Deaktivierung des Antriebs beträgt 5 Minuten nach Durchführung der Deaktivierungsschritte.
- **Schutzausrüstung erforderlich (Isolierende Handschuhe bis 1000 V, Gesichtsschutz).**

## Fahrzeug immobilisieren und deaktivieren

- Räder verkeilen, Feststellbremse betätigen und Taste P (Parken) drücken.

### Methode 1:

1. Prüfen ob das Hochvoltsystem eingeschaltet ist. Symbol:  .
2. Ist das System aktiv, Start-Stopp Knopf einmal betätigen.
3. Massekabel der 12 Volt Batterie abklemmen.





## Fahrzeug immobilisieren und deaktivieren

4. Notfalltrennkabel im Motorraum trennen.

Wenn der Notfalltrennkabel nicht erreichbar ist:

Service Disconnect Stecker wie dargestellt entfernen (isolierende Schutzhandschuhe bis 1000 V erforderlich).



Ist der Start/Stop-Knopf nicht zugänglich,  
Methode 2 Folgen!

- **Kann die 12 Volt Batterie nicht abgeklemmt werden, sind die Rückhaltesysteme weiterhin aktiv!**
- **Achtung: Die Spannung im Hochvoltsystem ist erst nach ca. 5 min. vollständig deaktiviert!**



## Fahrzeug immobilisieren und deaktivieren

### Methode 2:

1. Dargestellte Sicherungen aus dem Sicherungskasten entfernen.



2. Massekabel der 12 Volt Batterie abklemmen.



3. Notfalltrennkabel im Motorraum trennen.

Wenn der Notfalltrennkabel nicht erreichbar ist:

Service Disconnect Stecker wie dargestellt entfernen (isolierende Schutzhandschuhe bis 1000 V erforderlich).





## Fahrzeug immobilisieren und deaktivieren







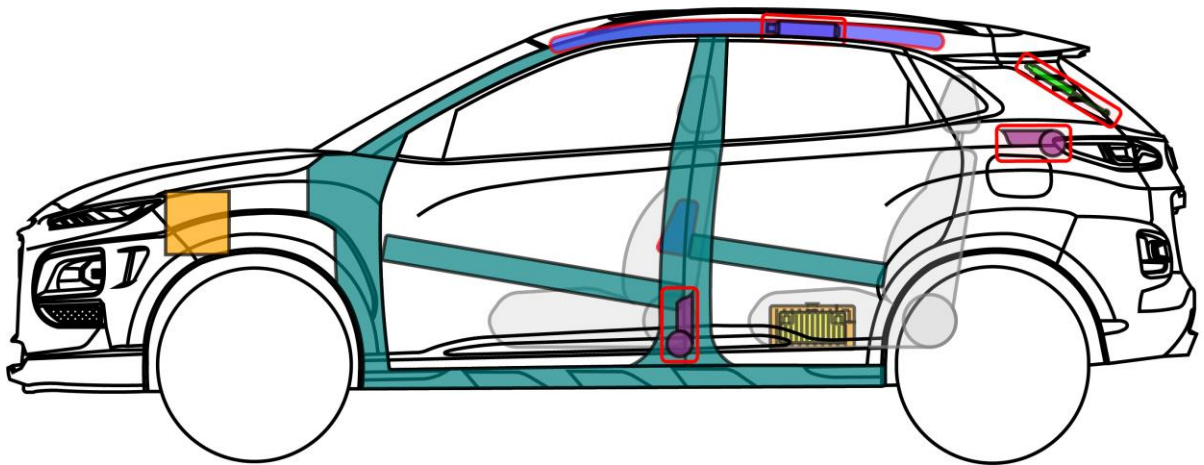
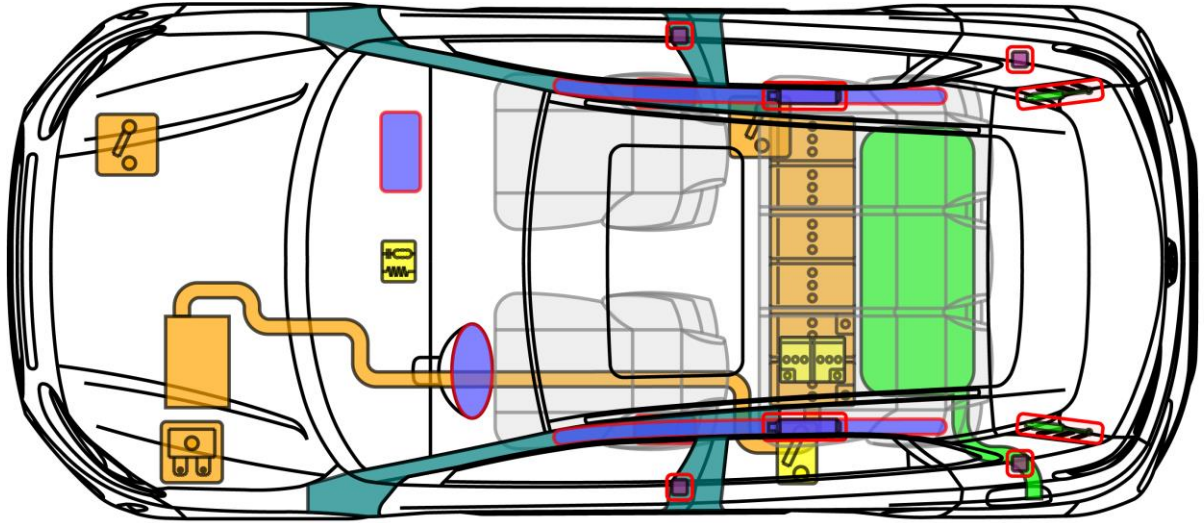



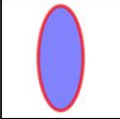
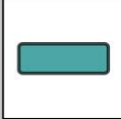

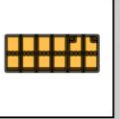
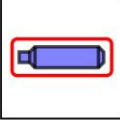
Service Disconnect Stecker wie dargestellt entfernen (isolierende Schutzhandschuhe bis 1000 V erforderlich).

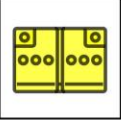

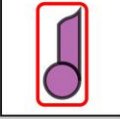
- **Kann die 12 Volt Batterie nicht abgeklemmt werden, sind die Rückhaltesysteme weiterhin aktiv!**
- **Achtung: Die Spannung im Hochvoltsystem ist erst nach ca. 5 min. vollständig deaktiviert!**

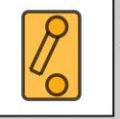

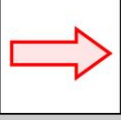
**Legende**

|   |                      |   |                            |   |                     |  |                                      |
|---|----------------------|---|----------------------------|---|---------------------|--|--------------------------------------|
|  | Airbag               |  | Karosserie-<br>verstärkung |  | Steuergerät         |  | Hochvolt-<br>batterie                |
|  | Gas-<br>generator    |  | Überroll-<br>schutz        |  | 12 V<br>Batterie    |  | Hochvolt-<br>leitung/<br>-komponente |
|  | Gurt-<br>straffer    |  | Gasdruck-<br>dämpfer       |  | Kraftstoff-<br>tank |  | Notfalltren-<br>stelle               |
|  | Brennstoff-<br>zelle |  | Sicherheits-<br>ventil     |  | Abblas-<br>richtung |  | Sicherungs-<br>kasten                |

**Kona Hybrid**



## Allgemeine Hinweise

- Bei Unfällen mit Airbag und/oder Gurtstrafferauslösung wird der Fahrzeugantrieb automatisch deaktiviert. Die Rückhaltesysteme sind weiterhin aktiv.
- Die Zeit bis zur vollständigen Deaktivierung des Antriebs beträgt 5 Minuten nach Durchführung der Deaktivierungsschritte.
- **Schutzausrüstung erforderlich (Isolierende Handschuhe bis 1000 V, Gesichtsschutz).**

## Fahrzeug immobilisieren und deaktivieren

- Räder verkeilen, Feststellbremse betätigen und Gangwahlhebel in Position P (Parken) bringen.



1. Prüfen ob das Hochvoltsystem eingeschaltet ist. Symbol:  .
2. Ist das System aktiv, Start-Stopp Knopf einmal betätigen.



Das Symbol darf nicht mehr leuchten!

Wenn der Start/Stop-Knopf nicht erreichbar ist:



**Kona Hybrid**



## Fahrzeug immobilisieren und deaktivieren

Dargestellte Sicherung aus dem Sicherungskasten entfernen.



3. Massekabel der 12 Volt Batterie unter der Rücksitzbank abklemmen.



4. Service Disconnect Stecker wie dargestellt entfernen.



**Schutzausrüstung erforderlich  
(Isolierende Handschuhe bis 1000 V,  
Gesichtsschutz).**

Wenn der Service Disconnect Stecker nicht erreichbar ist:

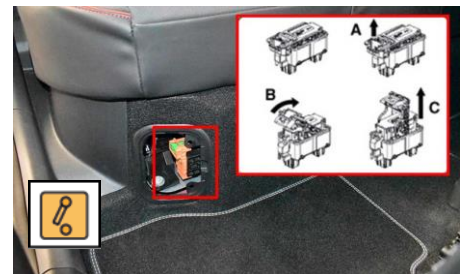







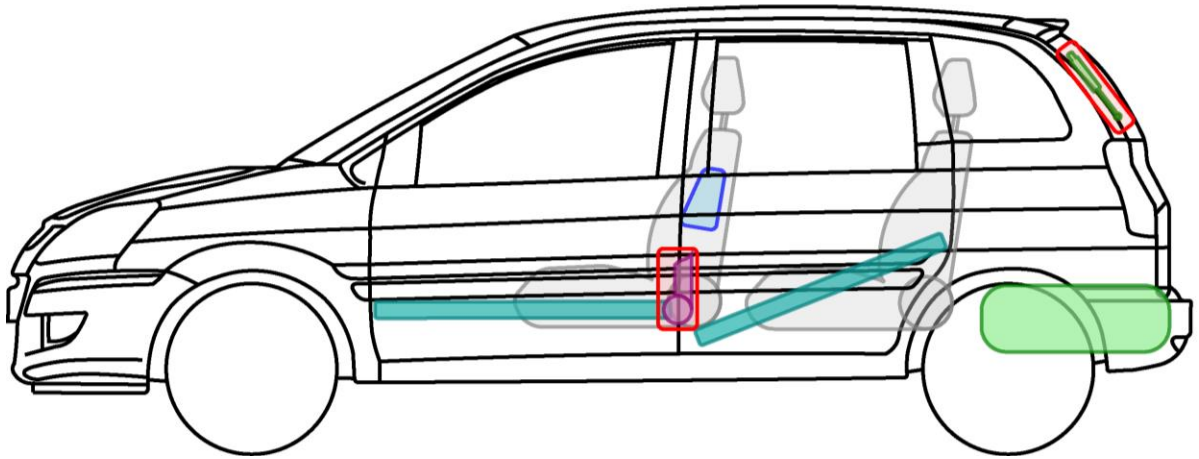
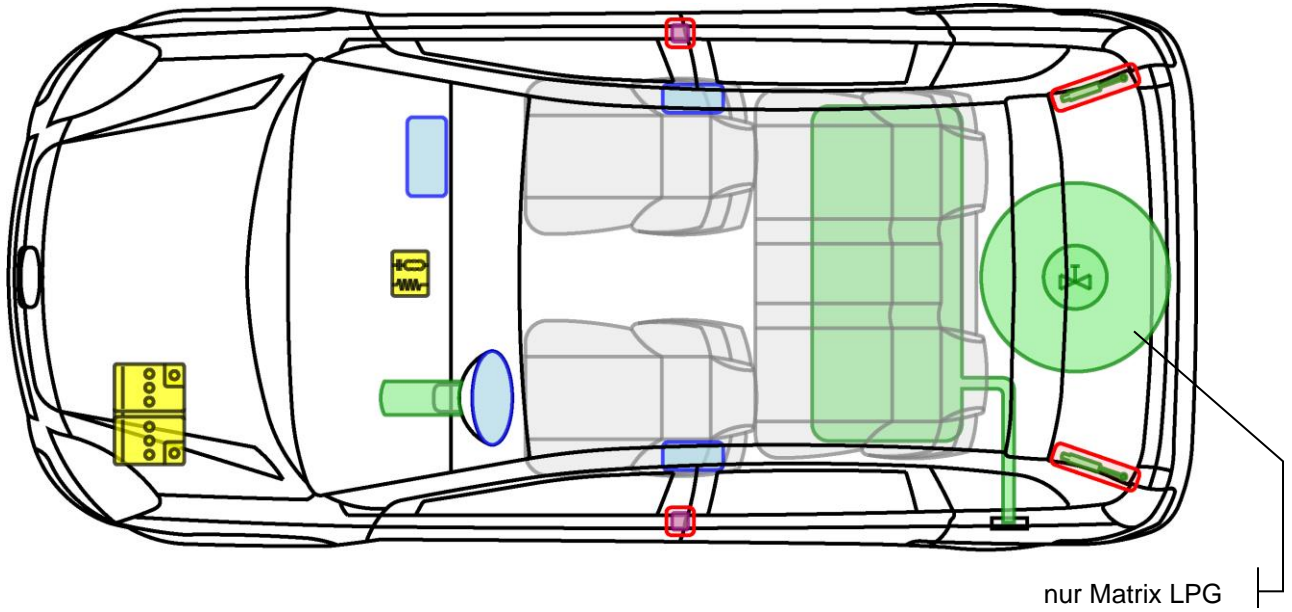

Notfalltrennkabel im Motorraum trennen.

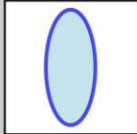

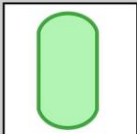
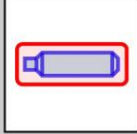
- **Kann die 12 Volt Batterie nicht abgeklemmt werden, sind die Rückhaltesysteme weiterhin aktiv!**
- **Achtung: Die Spannung im Hochvoltsystem ist erst nach ca. 5 min. vollständig deaktiviert!**

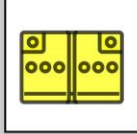

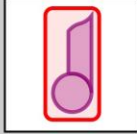
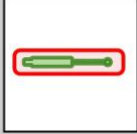
**Legende**







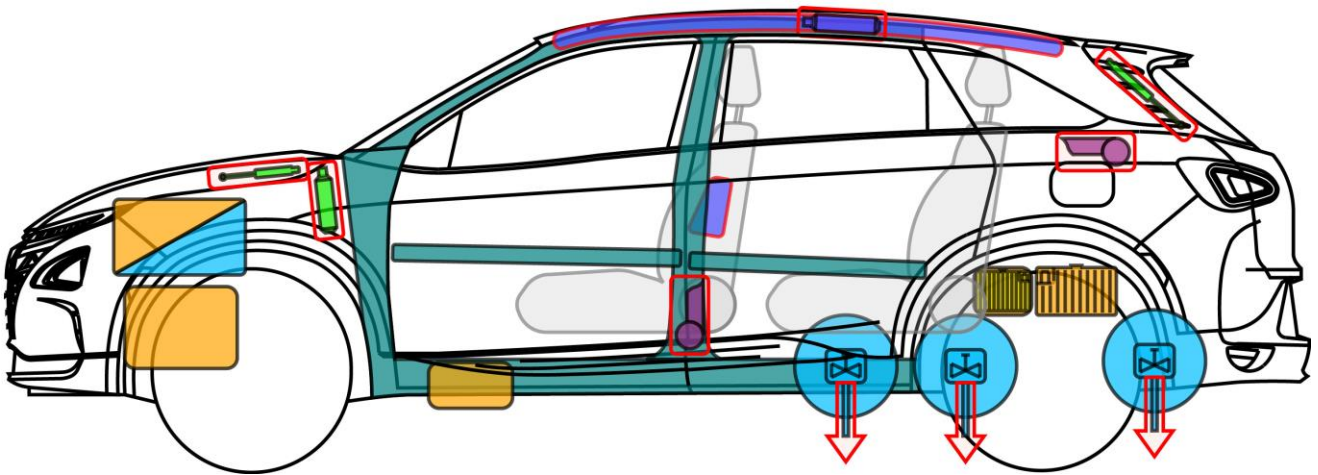
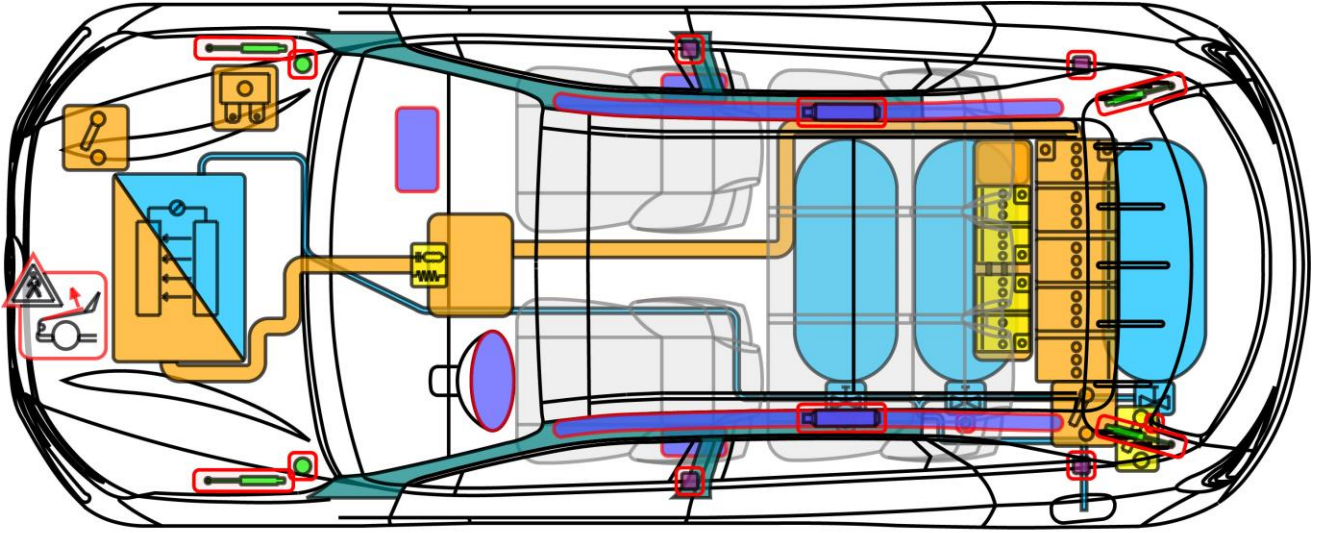

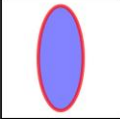
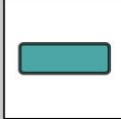

|   |                   |   |                            |   |                     |   |                            |
|---|-------------------|---|----------------------------|---|---------------------|---|----------------------------|
|  | Airbag            |  | Karosserie-<br>verstärkung |  | Steuergerät         |  | Gastank                    |
|  | Gas-<br>generator |  | Überroll-<br>schutz        |  | 12 V<br>Batterie    |  | Sicherheits-<br>ventil     |
|  | Gurt-<br>straffer |  | Gasdruck-<br>dämpfer       |  | Kraftstoff-<br>tank |  | Fußgänger-<br>schutzsystem |

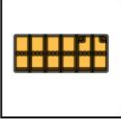
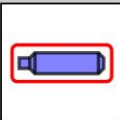
**Matrix**

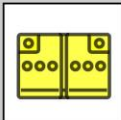

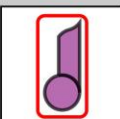

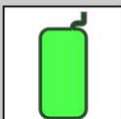
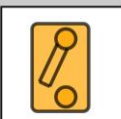
**Legende**

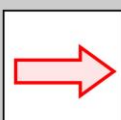
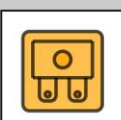
|   |                      |   |                            |   |                     |  |                                      |
|---|----------------------|---|----------------------------|---|---------------------|--|--------------------------------------|
|  | Airbag               |  | Karosserie-<br>verstärkung |  | Steuergerät         |  | Hochvolt-<br>batterie                |
|  | Gas-<br>generator    |  | Überroll-<br>schutz        |  | 12 V<br>Batterie    |  | Hochvolt-<br>leitung/<br>-komponente |
|  | Gurt-<br>straffer    |  | Gasdruck-<br>dämpfer       |  | Kraftstoff-<br>tank |  | Notfalltren-<br>stelle               |
|  | Brennstoff-<br>zelle |  | Sicherheits-<br>ventil     |  | Abblas-<br>richtung |  | Sicherungs-<br>kasten                |

**Nexo FCEV**



## Allgemeine Hinweise

- Fahrzeug mit elektrischem Brennstoffzellen-System.  
**Druckwasserstoffspeicherung.**
- Initialer Sicherheitsabstand: **50 m**
- Bereich der **Wasserstoff-Abblaseeinrichtung** freihalten (rote Pfeile)
- Hochvoltkabel verfügen über eine orangefarbene Isolierung.
- Hochvolt- und Wasserstoffsystem werden bei Unfällen mit Airbagauslösung i.d.R. automatisch abgeschaltet.

## Fahrzeug immobilisieren und deaktivieren

- Räder verkeilen, Feststellbremse betätigen und Taste P (Parken) drücken.

### Methode 1:

1. Prüfen ob das Hochvoltsystem eingeschaltet ist. Symbol:  .
2. Ist das System aktiv, Start-Stopp Knopf einmal betätigen.
3. Massekabel der 12 Volt Batterie abklemmen.





## Fahrzeug immobilisieren und deaktivieren

3. Massekabel der 12 Volt Batterie abklemmen.



4. Service Disconnect Stecker wie dargestellt entfernen (isolierende Schutzhandschuhe bis 1000 V erforderlich).

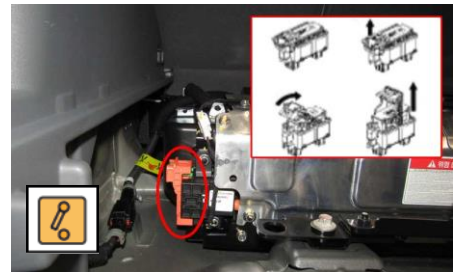

Wenn der Service Disconnect Stecker nicht erreichbar ist:

Notfalltrennkabel im Motorraum trennen.



Ist der Start/Stop-Knopf nicht zugänglich,  
Methode 2 Folgen!

- **Kann die 12 Volt Batterie nicht abgeklemmt werden, sind die Rückhaltesysteme weiterhin aktiv!**
- **Achtung: Die Spannung im Hochvoltsystem ist erst nach ca. 10 min. vollständig deaktiviert!**



## Fahrzeug immobilisieren und deaktivieren

### Methode 2:

1. Dargestellte Sicherungen aus dem Sicherungskasten entfernen.
2. Massekabel der 12 Volt Batterie abklemmen.

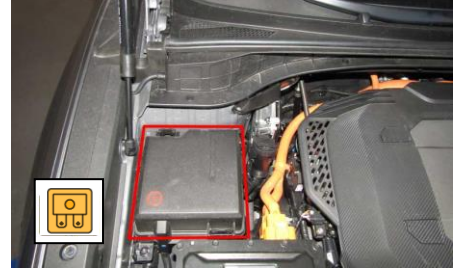



## Fahrzeug immobilisieren und deaktivieren

3. Service Disconnect Stecker wie dargestellt entfernen (isolierende Schutzhandschuhe bis 1000 V erforderlich).

Wenn der Service Disconnect Stecker nicht erreichbar ist:







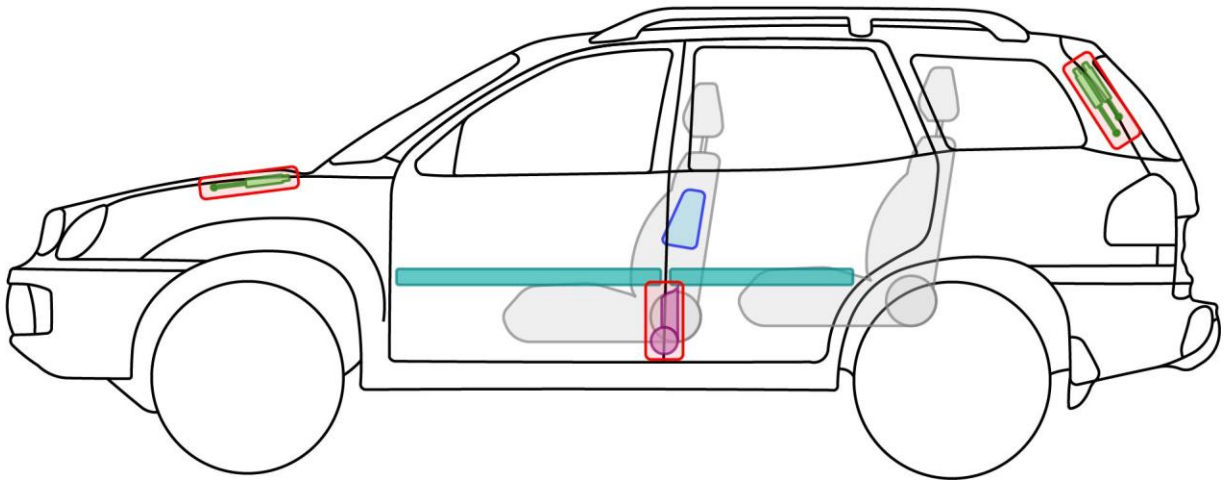
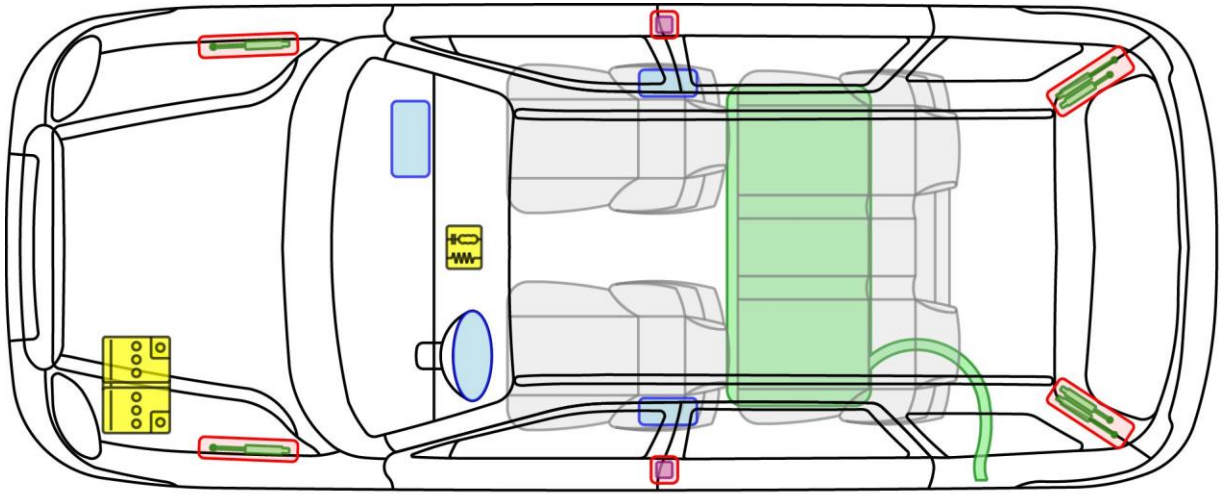

Notfalltrennkabel im Motorraum trennen.

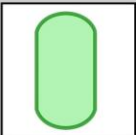
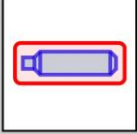

- **Kann die 12 Volt Batterie nicht abgeklemmt werden, sind die Rückhaltesysteme weiterhin aktiv!**
- **Achtung: Die Spannung im Hochvoltsystem ist erst nach ca. 10 min. vollständig deaktiviert!**

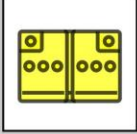

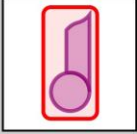
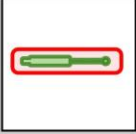
**Legende**

|   |                   |   |                            |   |                     |   |                            |
|---|-------------------|---|----------------------------|---|---------------------|---|----------------------------|
|  | Airbag            |  | Karosserie-<br>verstärkung |  | Steuergerät         |  | Gastank                    |
|  | Gas-<br>generator |  | Überroll-<br>schutz        |  | 12 V<br>Batterie    |  | Sicherheits-<br>ventil     |
|  | Gurt-<br>straffer |  | Gasdruck-<br>dämpfer       |  | Kraftstoff-<br>tank |  | Fußgänger-<br>schutzsystem |



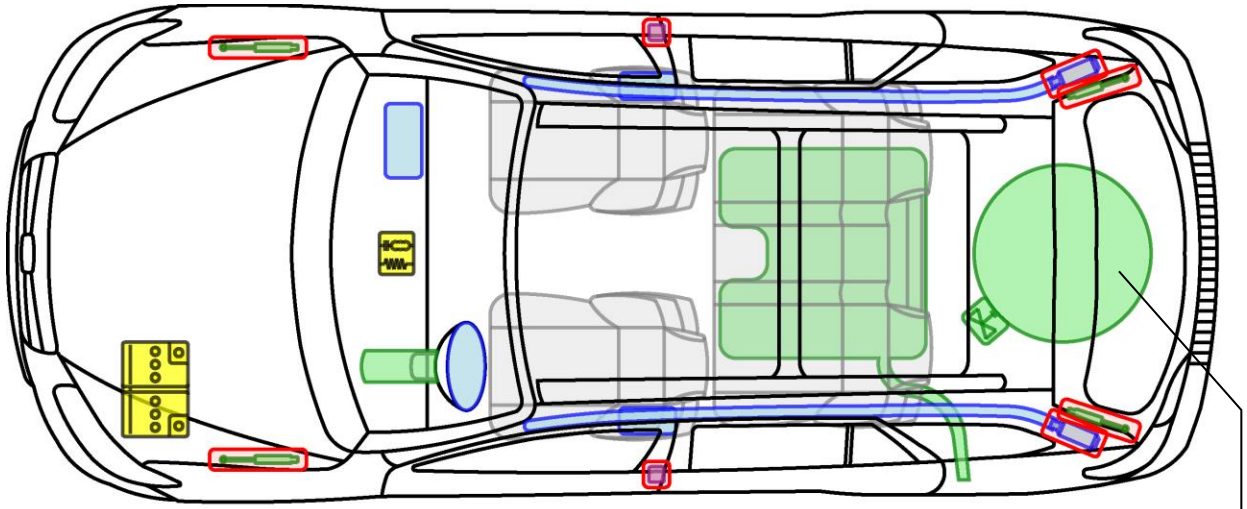



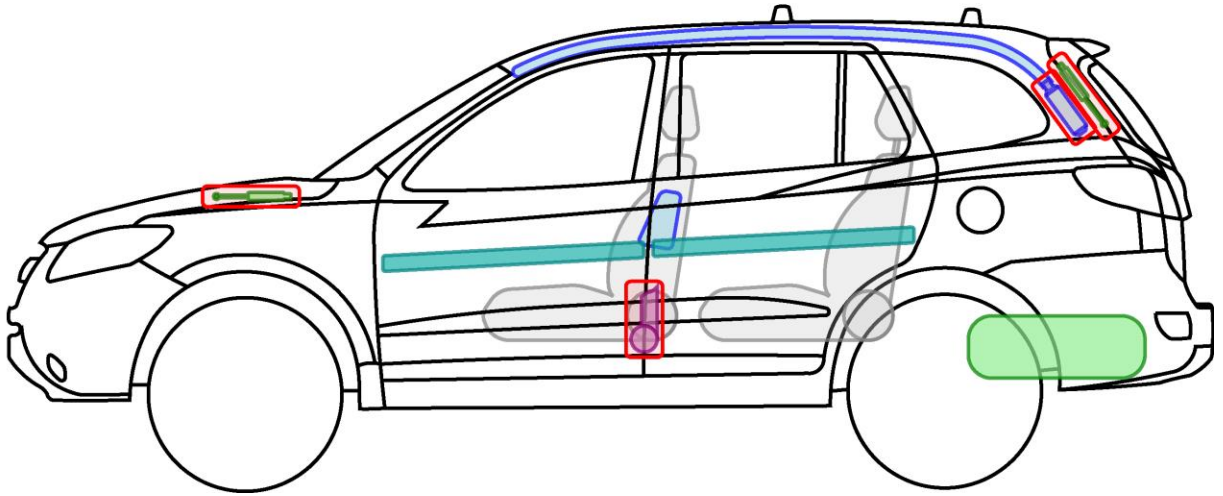

**Santa Fe**

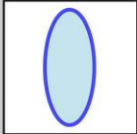

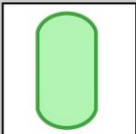
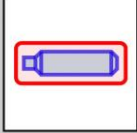
nur Santa Fe LPG

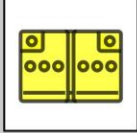

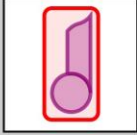
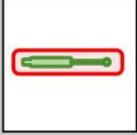





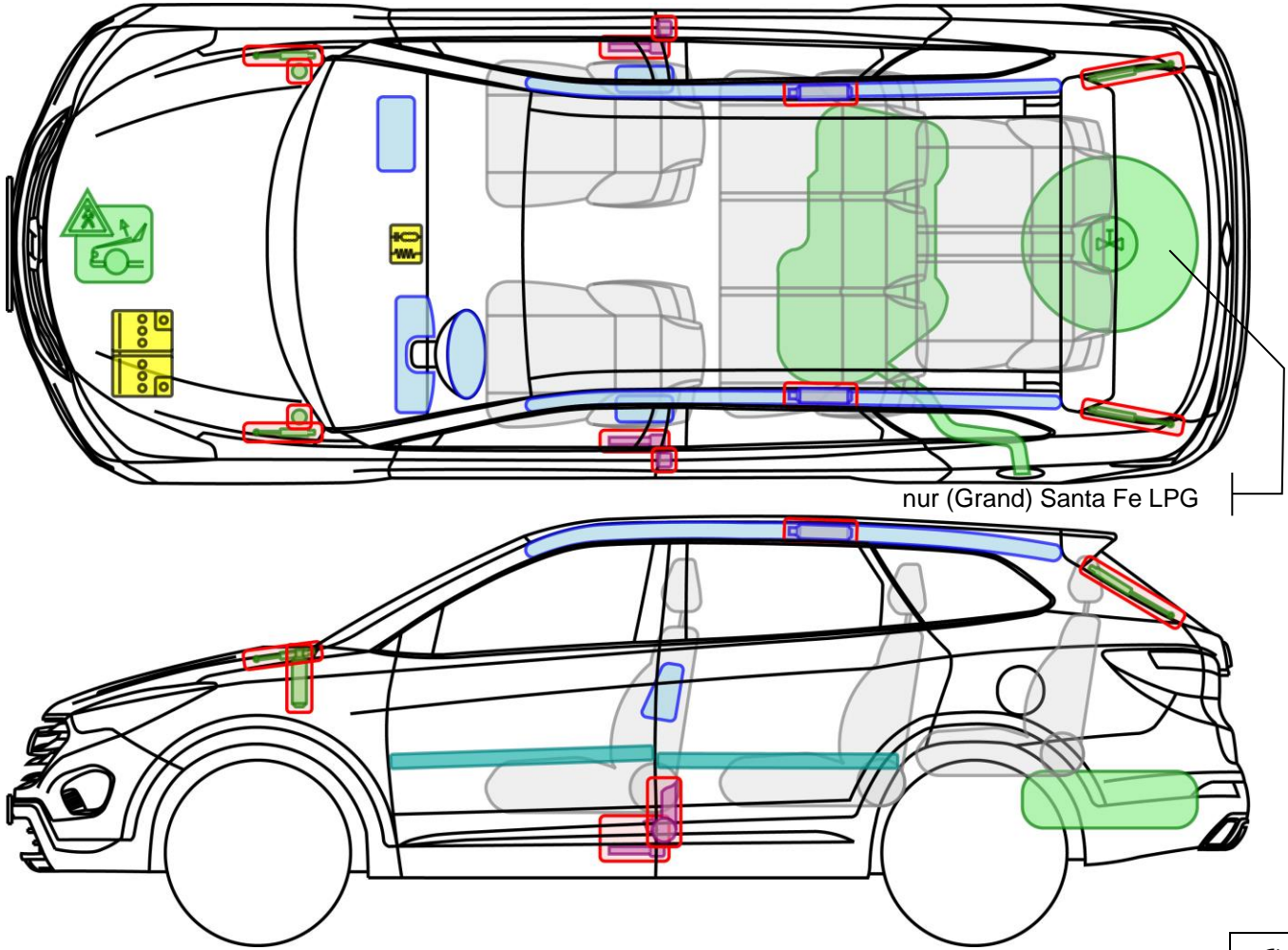

**Legende**

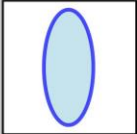
|   |                   |   |                            |   |                     |   |                            |
|---|-------------------|---|----------------------------|---|---------------------|---|----------------------------|
|  | Airbag            |  | Karosserie-<br>verstärkung |  | Steuergerät         |  | Gastank                    |
|  | Gas-<br>generator |  | Überroll-<br>schutz        |  | 12 V<br>Batterie    |  | Sicherheits-<br>ventil     |
|  | Gurt-<br>straffer |  | Gasdruck-<br>dämpfer       |  | Kraftstoff-<br>tank |  | Fußgänger-<br>schutzsystem |

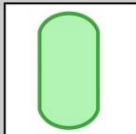
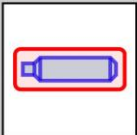
**Santa Fe**

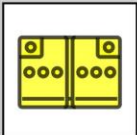

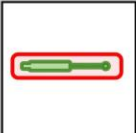
**Legende**







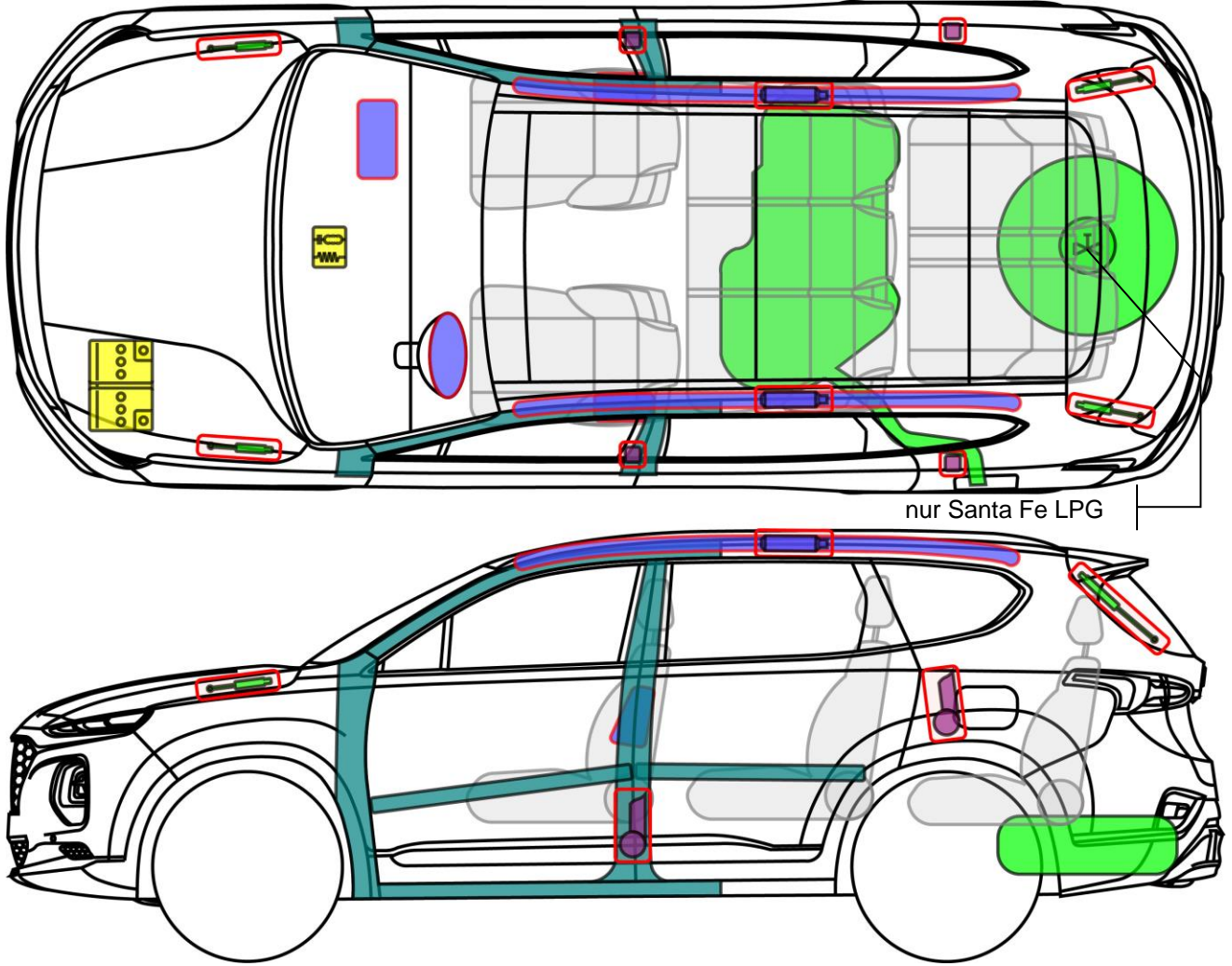

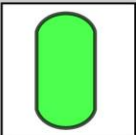
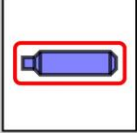

|   |                   |   |                            |   |                     |   |                            |
|---|-------------------|---|----------------------------|---|---------------------|---|----------------------------|
|  | Airbag            |  | Karosserie-<br>verstärkung |  | Steuergerät         |  | Gastank                    |
|  | Gas-<br>generator |  | Überroll-<br>schutz        |  | 12 V<br>Batterie    |  | Sicherheits-<br>ventil     |
|  | Gurt-<br>straffer |  | Gasdruck-<br>dämpfer       |  | Kraftstoff-<br>tank |  | Fußgänger-<br>schutzsystem |

**(Grand) Santa Fe**

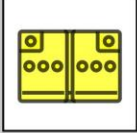

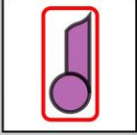







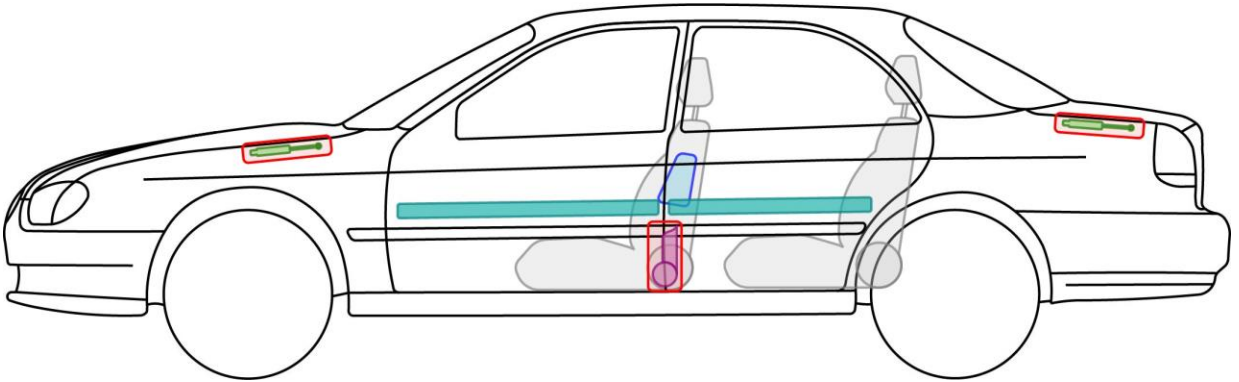
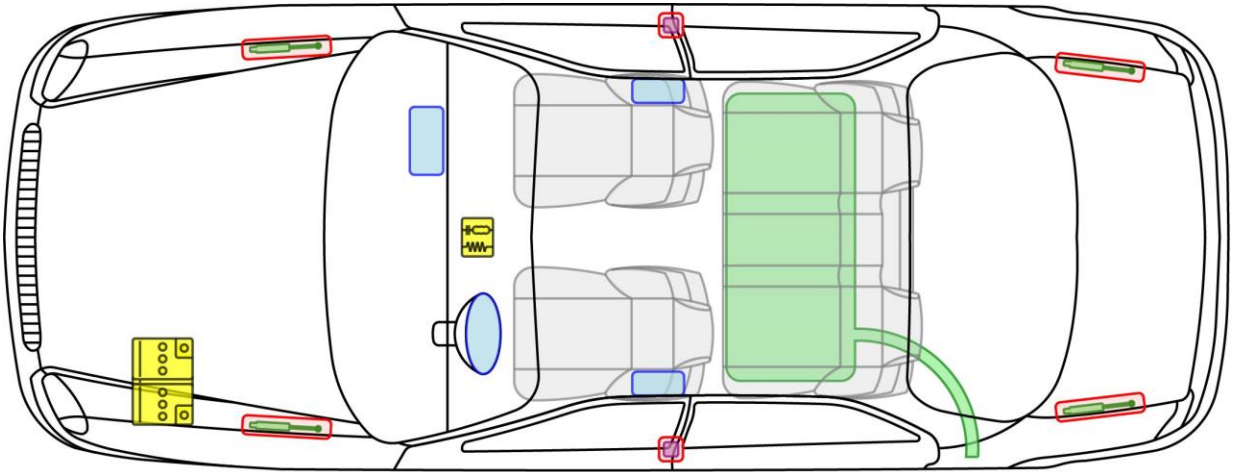



**Legende**

|   |                   |   |                            |   |                     |   |                            |
|---|-------------------|---|----------------------------|---|---------------------|---|----------------------------|
|  | Airbag            |  | Karosserie-<br>verstärkung |  | Steuergerät         |  | Gastank                    |
|  | Gas-<br>generator |  | Überroll-<br>schutz        |  | 12 V<br>Batterie    |  | Sicherheits-<br>ventil     |
|  | Gurt-<br>straffer |  | Gasdruck-<br>dämpfer       |  | Kraftstoff-<br>tank |  | Fußgänger-<br>schutzsystem |

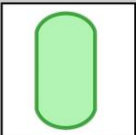
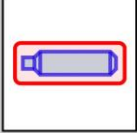
**Santa Fe**

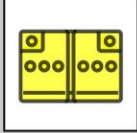

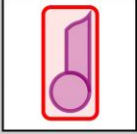
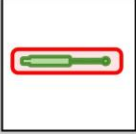





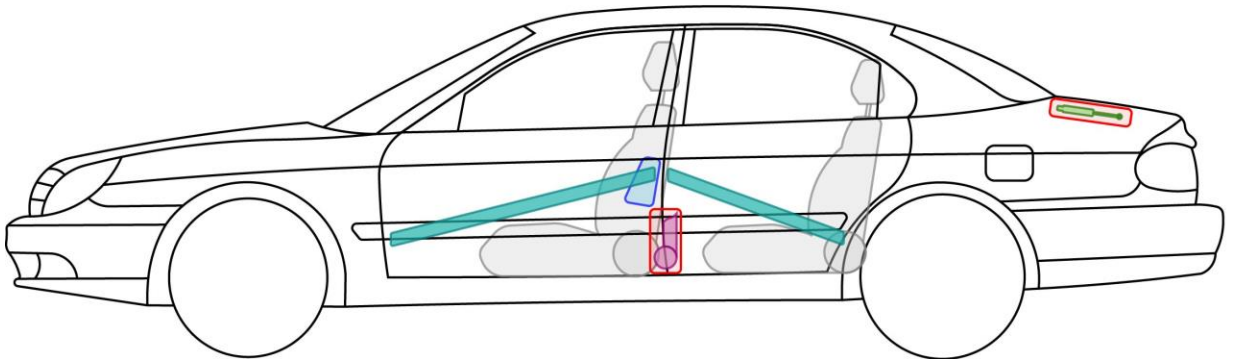
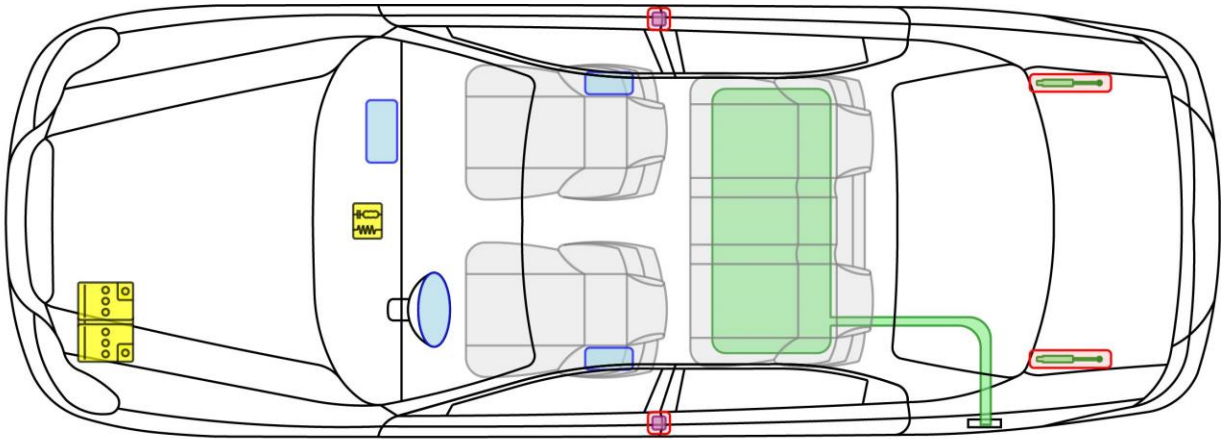

**Legende**

|   |                   |   |                            |   |                     |   |                            |
|---|-------------------|---|----------------------------|---|---------------------|---|----------------------------|
|  | Airbag            |  | Karosserie-<br>verstärkung |  | Steuergerät         |  | Gastank                    |
|  | Gas-<br>generator |  | Überroll-<br>schutz        |  | 12 V<br>Batterie    |  | Sicherheits-<br>ventil     |
|  | Gurt-<br>straffer |  | Gasdruck-<br>dämpfer       |  | Kraftstoff-<br>tank |  | Fußgänger-<br>schutzsystem |

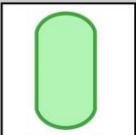
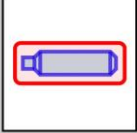
**Sonata**

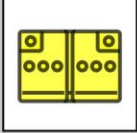

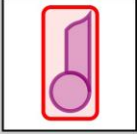
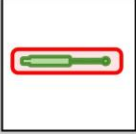
**Legende**

|   |                   |   |                            |   |                     |   |                            |
|---|-------------------|---|----------------------------|---|---------------------|---|----------------------------|
|  | Airbag            |  | Karosserie-<br>verstärkung |  | Steuergerät         |  | Gastank                    |
|  | Gas-<br>generator |  | Überroll-<br>schutz        |  | 12 V<br>Batterie    |  | Sicherheits-<br>ventil     |
|  | Gurt-<br>straffer |  | Gasdruck-<br>dämpfer       |  | Kraftstoff-<br>tank |  | Fußgänger-<br>schutzsystem |



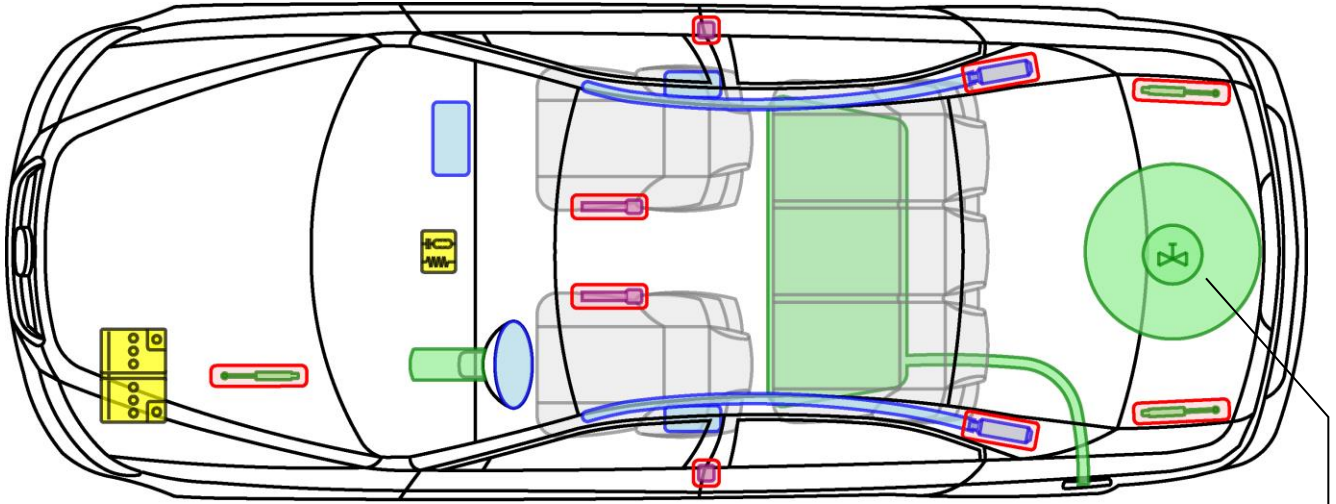



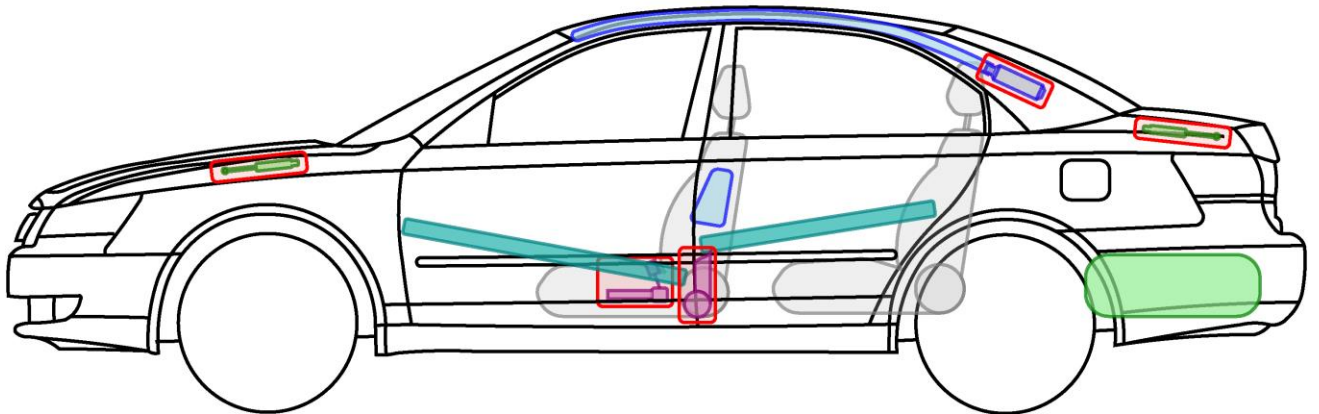

**Sonata**

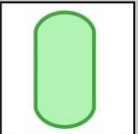
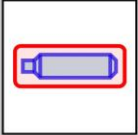

nur Sonata LPG

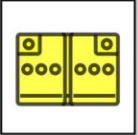

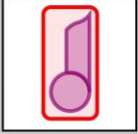
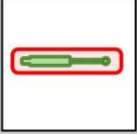





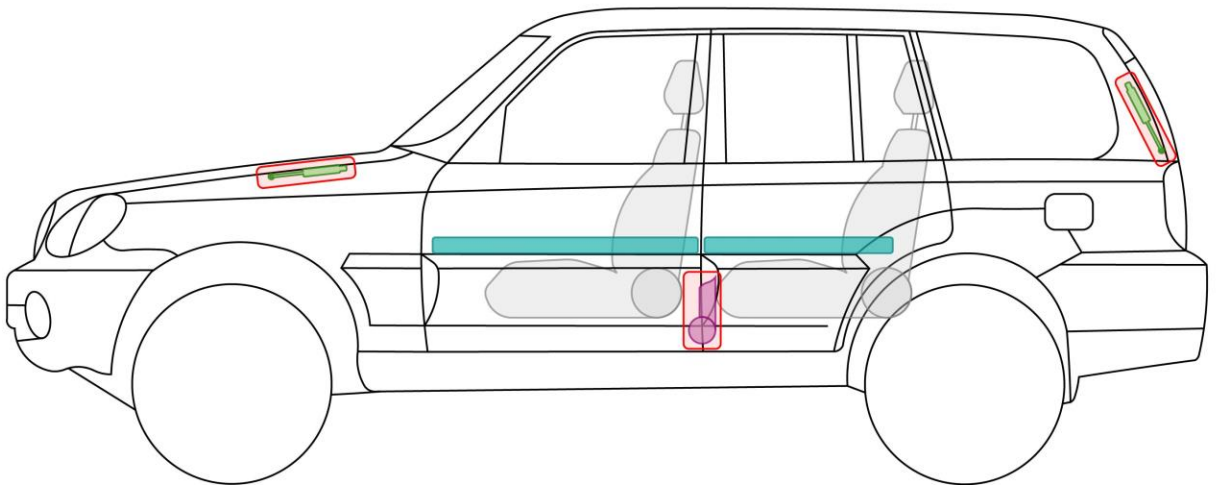
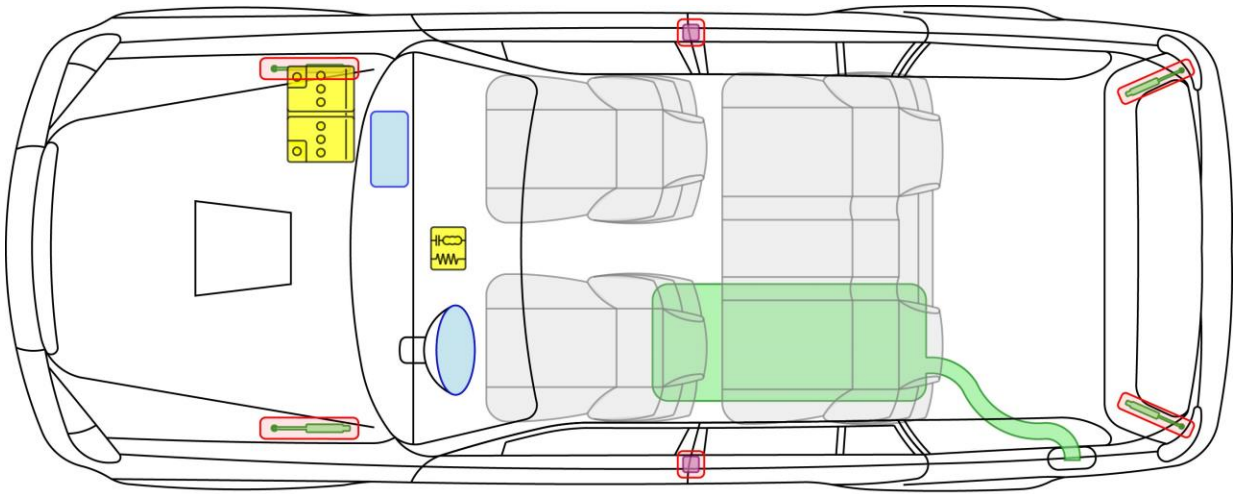

**Legende**

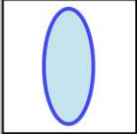
|   |                   |   |                            |   |                     |   |                            |
|---|-------------------|---|----------------------------|---|---------------------|---|----------------------------|
|  | Airbag            |  | Karosserie-<br>verstärkung |  | Steuergerät         |  | Gastank                    |
|  | Gas-<br>generator |  | Überroll-<br>schutz        |  | 12 V<br>Batterie    |  | Sicherheits-<br>ventil     |
|  | Gurt-<br>straffer |  | Gasdruck-<br>dämpfer       |  | Kraftstoff-<br>tank |  | Fußgänger-<br>schutzsystem |

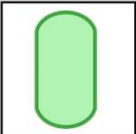
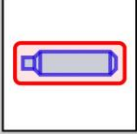
**Sonata**

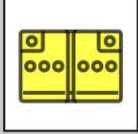

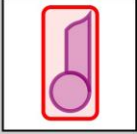
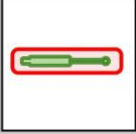





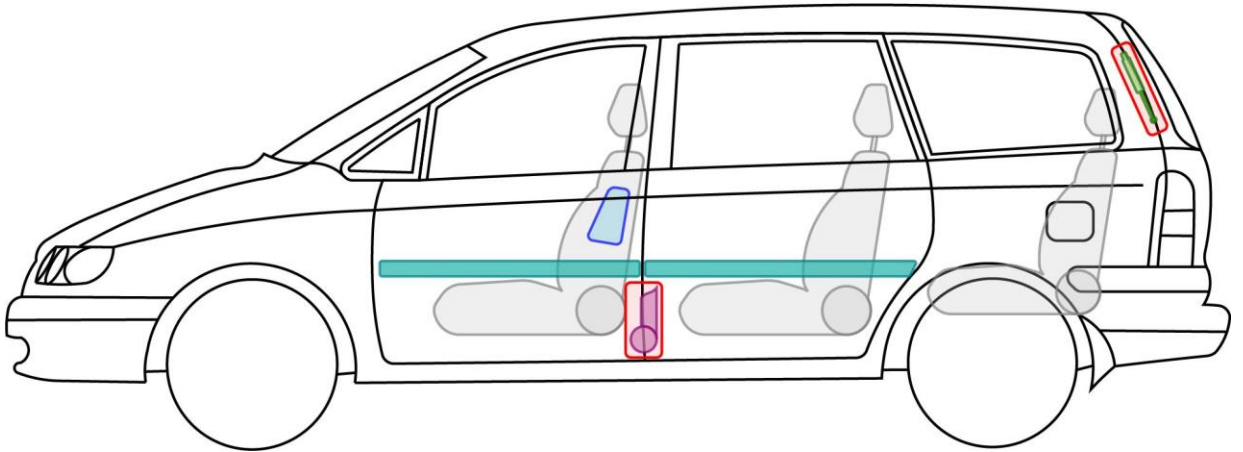
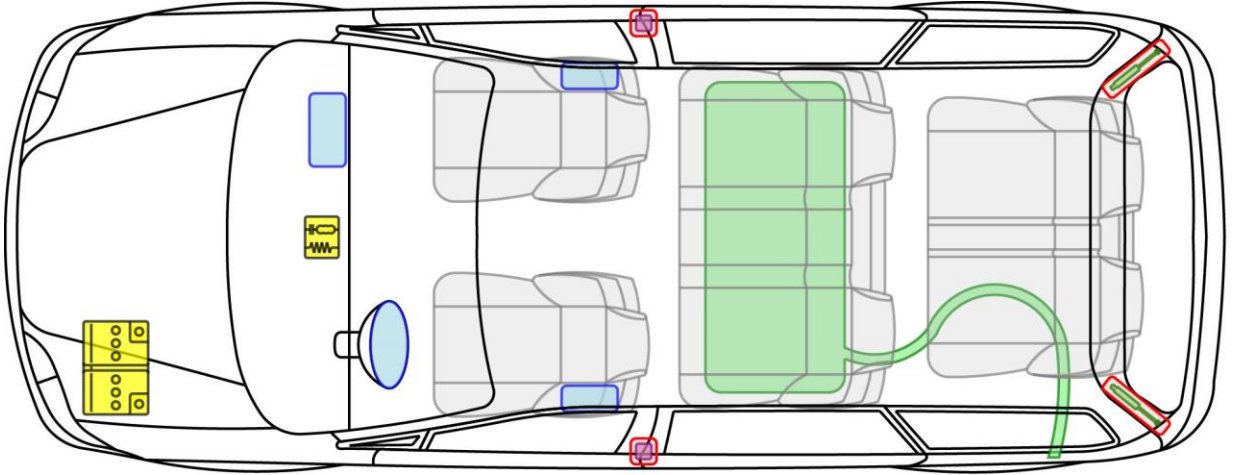

**Legende**

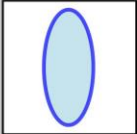
|   |                   |   |                            |   |                     |   |                            |
|---|-------------------|---|----------------------------|---|---------------------|---|----------------------------|
|  | Airbag            |  | Karosserie-<br>verstärkung |  | Steuergerät         |  | Gastank                    |
|  | Gas-<br>generator |  | Überroll-<br>schutz        |  | 12 V<br>Batterie    |  | Sicherheits-<br>ventil     |
|  | Gurt-<br>straffer |  | Gasdruck-<br>dämpfer       |  | Kraftstoff-<br>tank |  | Fußgänger-<br>schutzsystem |

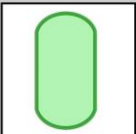
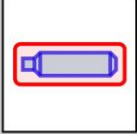
**Terracan**

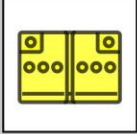

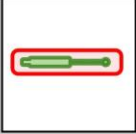
**Legende**

|   |                   |   |                            |   |                     |   |                            |
|---|-------------------|---|----------------------------|---|---------------------|---|----------------------------|
|  | Airbag            |  | Karosserie-<br>verstärkung |  | Steuergerät         |  | Gastank                    |
|  | Gas-<br>generator |  | Überroll-<br>schutz        |  | 12 V<br>Batterie    |  | Sicherheits-<br>ventil     |
|  | Gurt-<br>straffer |  | Gasdruck-<br>dämpfer       |  | Kraftstoff-<br>tank |  | Fußgänger-<br>schutzsystem |



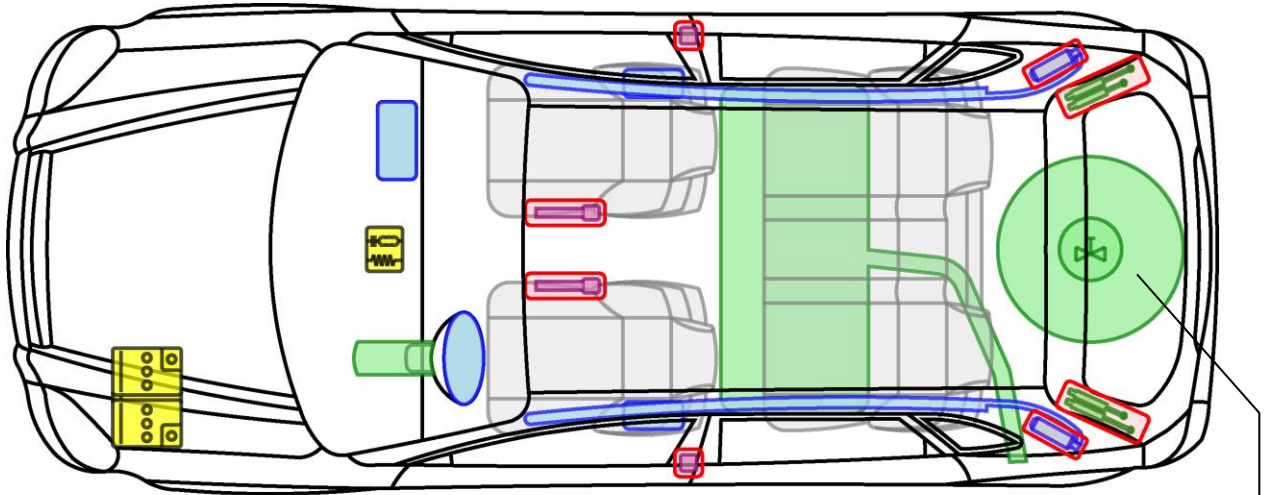



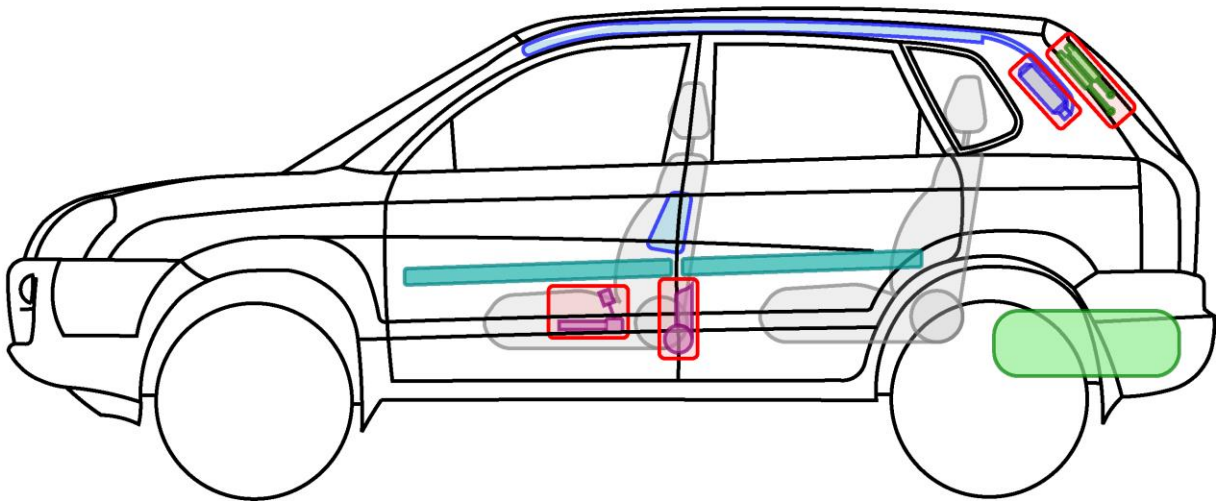

**Trajeto**

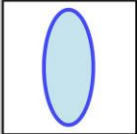

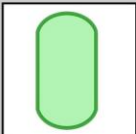
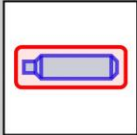
nur Tucson LPG

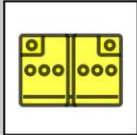

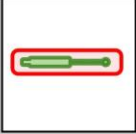
**Legende**

|   |                   |   |                            |   |                     |   |                            |
|---|-------------------|---|----------------------------|---|---------------------|---|----------------------------|
|  | Airbag            |  | Karosserie-<br>verstärkung |  | Steuergerät         |  | Gastank                    |
|  | Gas-<br>generator |  | Überroll-<br>schutz        |  | 12 V<br>Batterie    |  | Sicherheits-<br>ventil     |
|  | Gurt-<br>straffer |  | Gasdruck-<br>dämpfer       |  | Kraftstoff-<br>tank |  | Fußgänger-<br>schutzsystem |



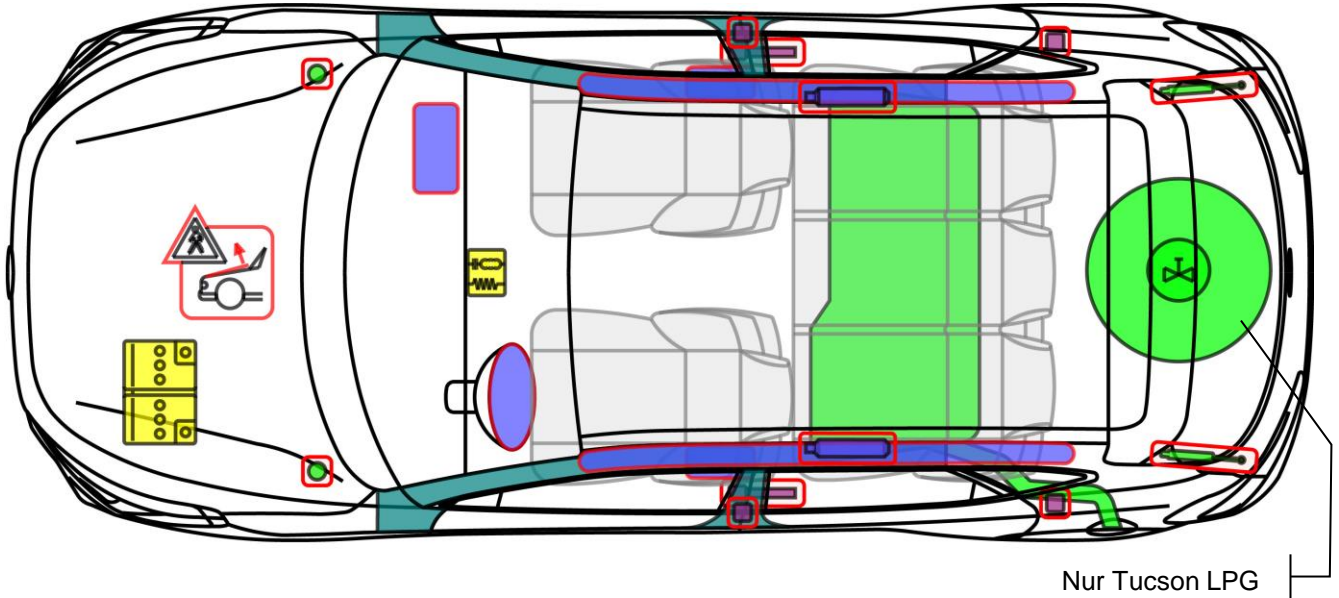



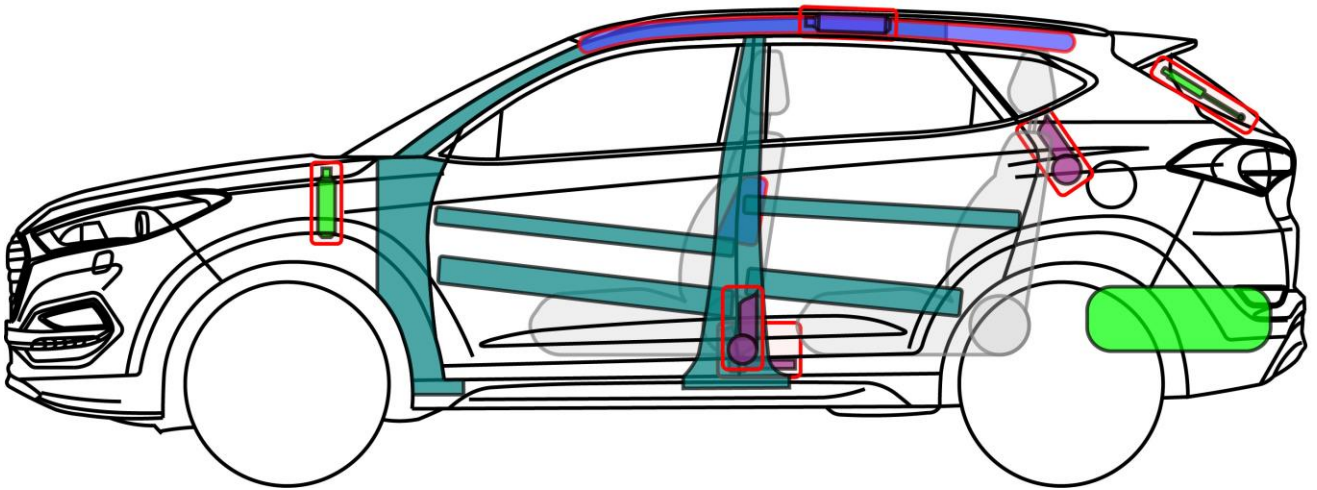

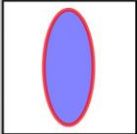

**Tucson**

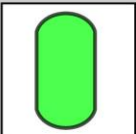
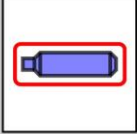

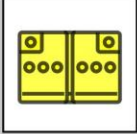
Nur Tucson LPG

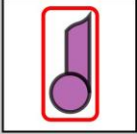

**Legende**

|   |                   |   |                            |   |                     |   |                            |
|---|-------------------|---|----------------------------|---|---------------------|---|----------------------------|
|  | Airbag            |  | Karosserie-<br>verstärkung |  | Steuergerät         |  | Gastank                    |
|  | Gas-<br>generator |  | Überroll-<br>schutz        |  | 12 V<br>Batterie    |  | Sicherheits-<br>ventil     |
|  | Gurt-<br>straffer |  | Gasdruck-<br>dämpfer       |  | Kraftstoff-<br>tank |  | Fußgänger-<br>schutzsystem |

**Tucson**



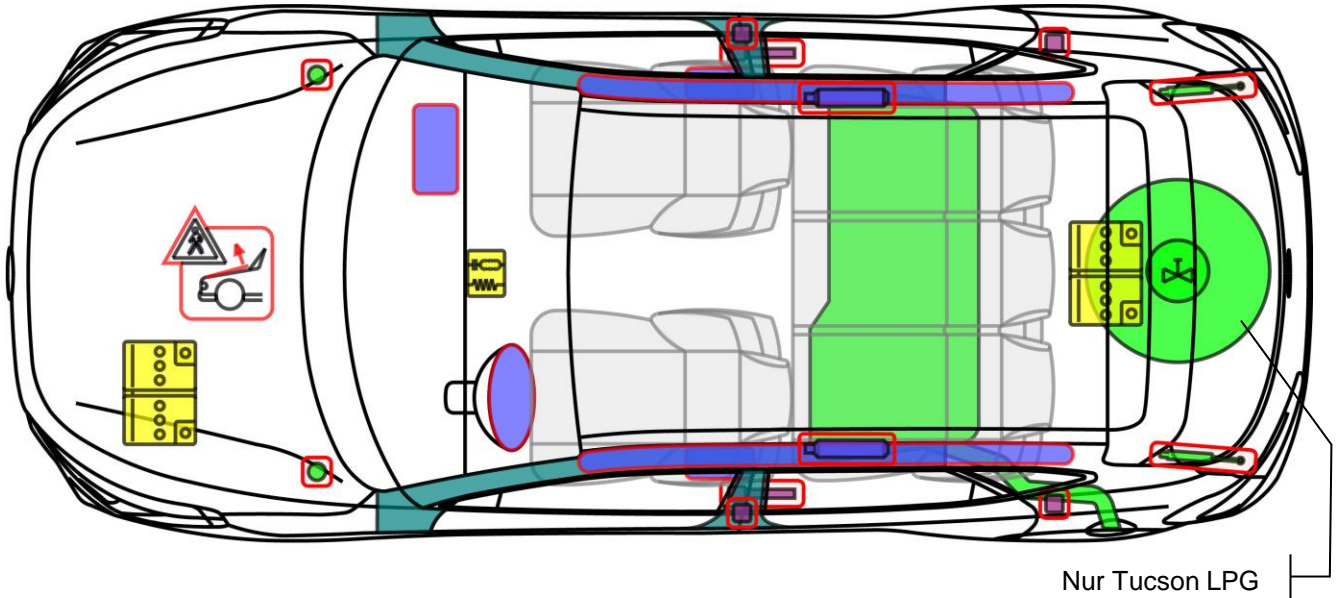



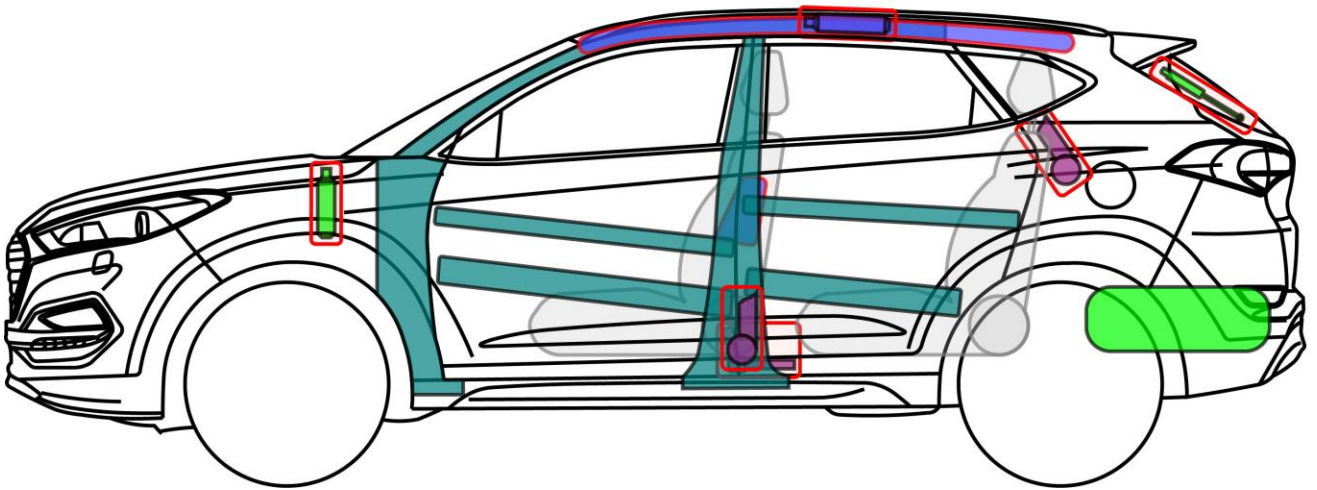



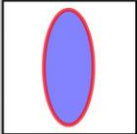

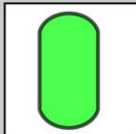
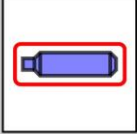

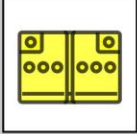
Nur Tucson LPG

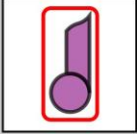







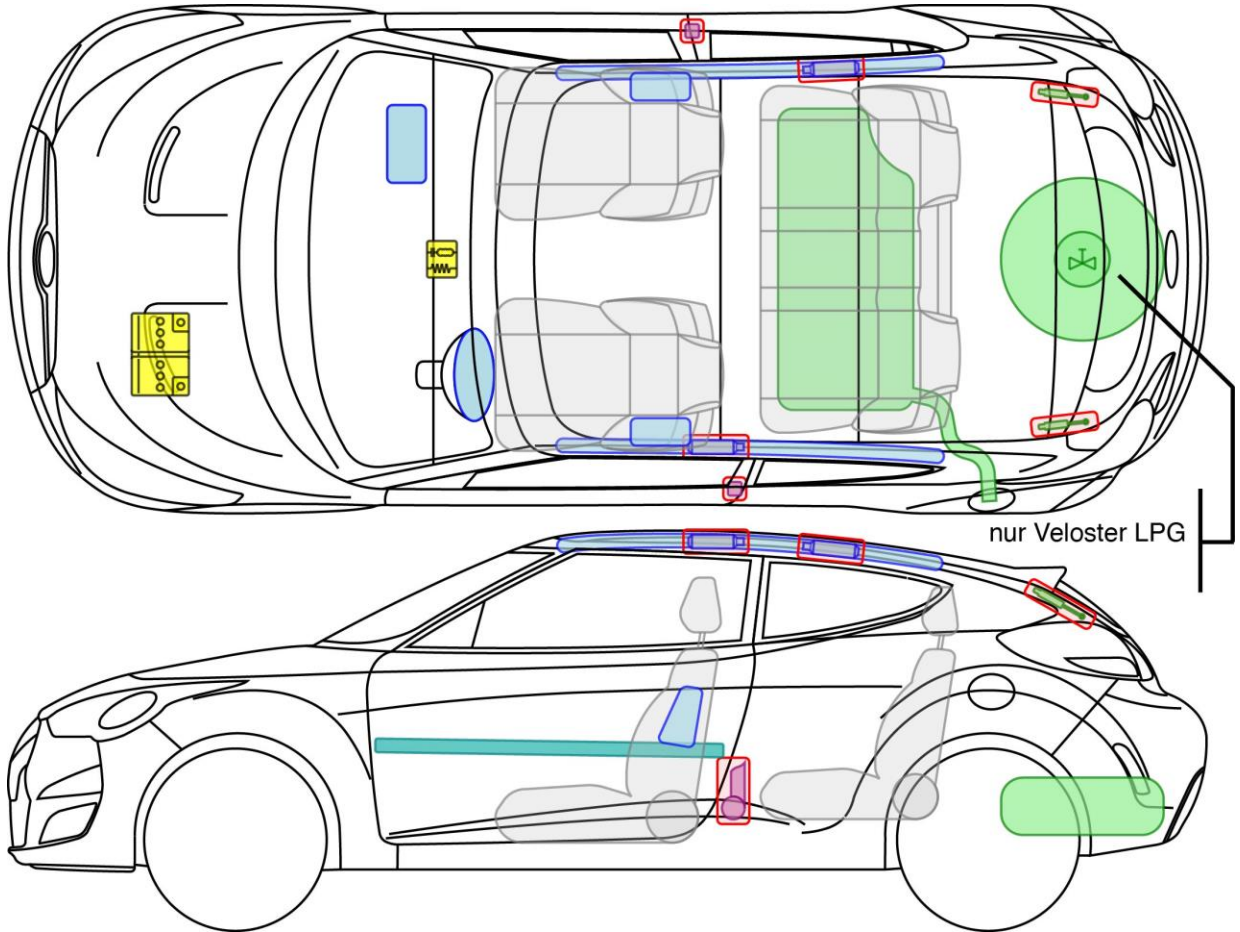

**Legende**

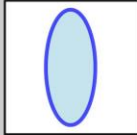
|   |                   |   |                            |   |                     |   |                            |
|---|-------------------|---|----------------------------|---|---------------------|---|----------------------------|
|  | Airbag            |  | Karosserie-<br>verstärkung |  | Steuergerät         |  | Gastank                    |
|  | Gas-<br>generator |  | Überroll-<br>schutz        |  | 12 V<br>Batterie    |  | Sicherheits-<br>ventil     |
|  | Gurt-<br>straffer |  | Gasdruck-<br>dämpfer       |  | Kraftstoff-<br>tank |  | Fußgänger-<br>schutzsystem |

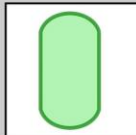
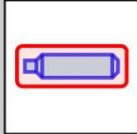
**Tucson**

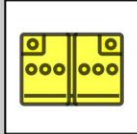

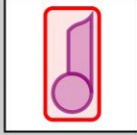
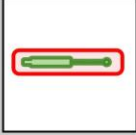





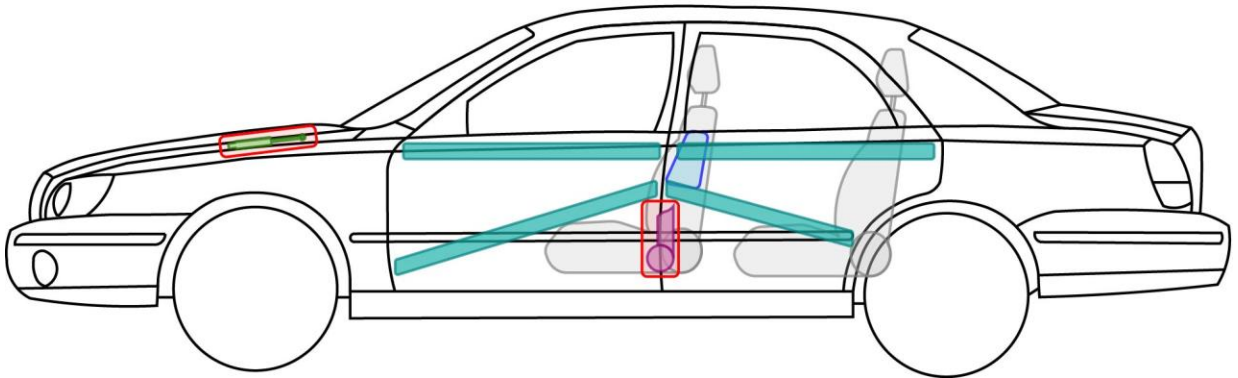
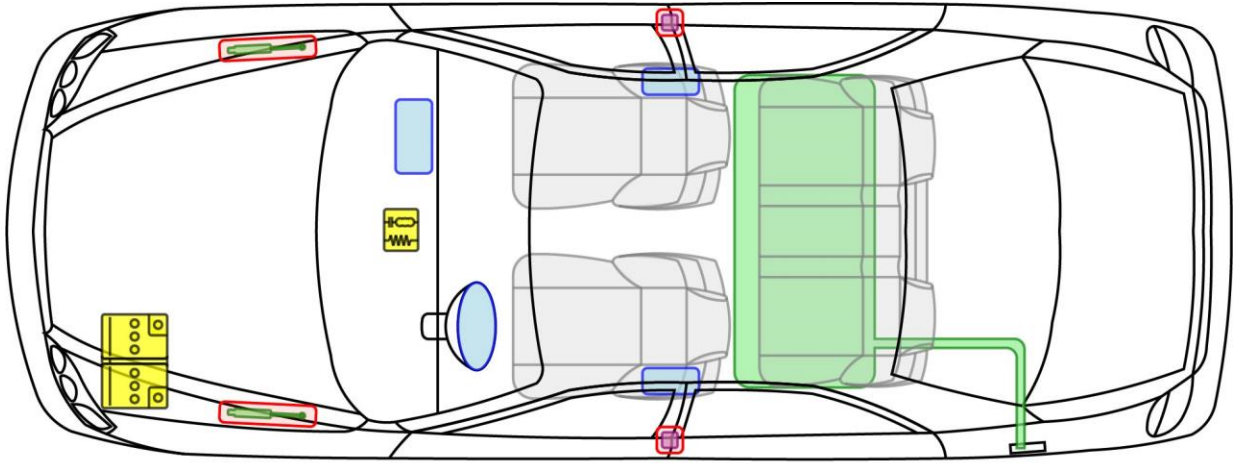

**Legende**

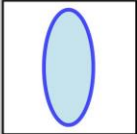
|   |                   |   |                            |   |                     |   |                            |
|---|-------------------|---|----------------------------|---|---------------------|---|----------------------------|
|  | Airbag            |  | Karosserie-<br>verstärkung |  | Steuergerät         |  | Gastank                    |
|  | Gas-<br>generator |  | Überroll-<br>schutz        |  | 12 V<br>Batterie    |  | Sicherheits-<br>ventil     |
|  | Gurt-<br>straffer |  | Gasdruck-<br>dämpfer       |  | Kraftstoff-<br>tank |  | Fußgänger-<br>schutzsystem |

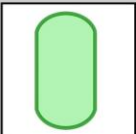
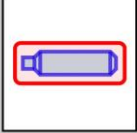
**Veloster**

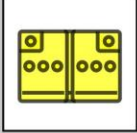

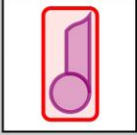
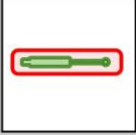
**Legende**

|   |                   |   |                            |   |                     |   |                            |
|---|-------------------|---|----------------------------|---|---------------------|---|----------------------------|
|  | Airbag            |  | Karosserie-<br>verstärkung |  | Steuergerät         |  | Gastank                    |
|  | Gas-<br>generator |  | Überroll-<br>schutz        |  | 12 V<br>Batterie    |  | Sicherheits-<br>ventil     |
|  | Gurt-<br>straffer |  | Gasdruck-<br>dämpfer       |  | Kraftstoff-<br>tank |  | Fußgänger-<br>schutzsystem |

**XG**