

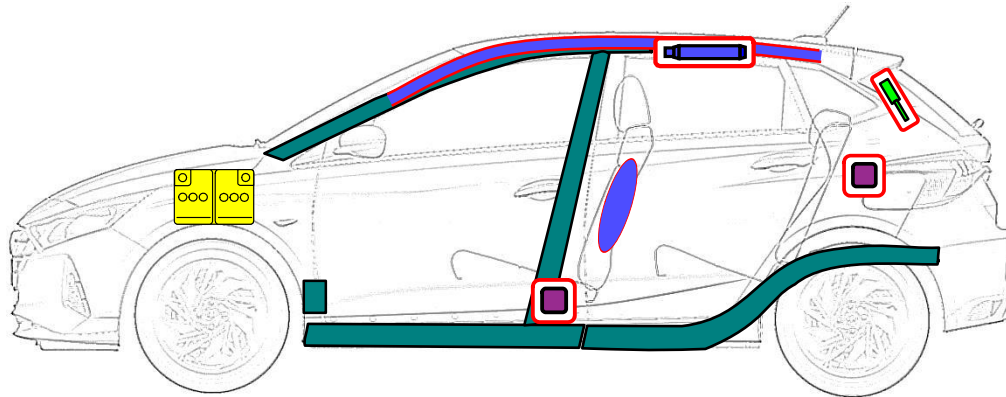

Hyundai i20
5 doors
From August 2020

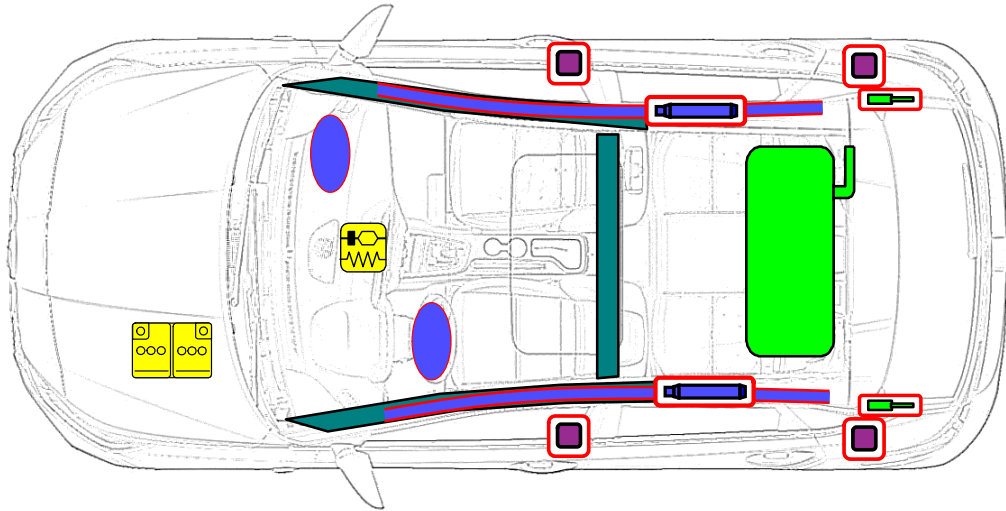

	Airbag		Stored gas inflator		Seat belt pretensioner		SRS control unit		Pedestrian protection active system
	Automatic rollover protection system		Gas strut/Preloaded spring		High strength zone		Zone requiring special attention		
	Battery low voltage		Ultra capacitor, low voltage		Fuel tank		Gas tank		Safety valve
	High voltage battery pack		High voltage power cable/ component		High voltage disconnect		Fuse box disabling high voltage system		Ultra capacitor, high voltage

ID No.	Version No.	Version date	Page
NLH-BC3-RSI-01-202104	01	04/2021	1 of 4

1. Identification / recognition



2. Immobilisation / stabilisation / lifting

■ Immobilisation



Pull up the parking brake as far as possible

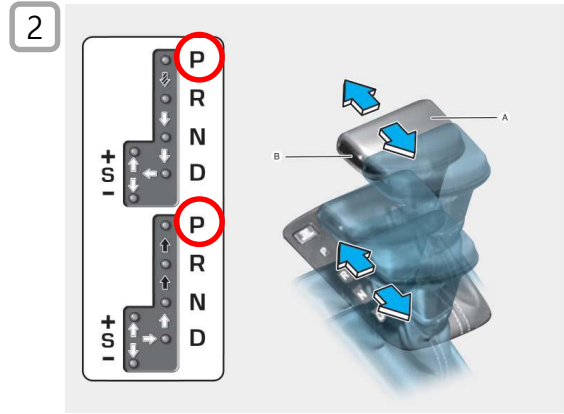

If automatic transmission: move shift lever to parking position (P)

■ Lifting positions at car underbody : ●

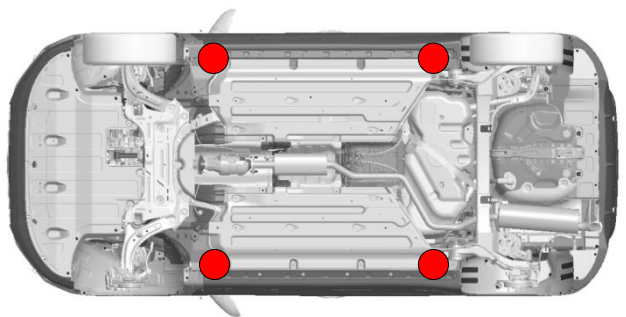
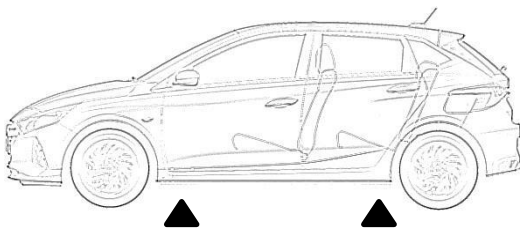

ID No.	Version No.	Version date	Page
NLH-BC3-RSI-01-202104	01	04/2021	2 of 4

3. Disable direct hazards / safety regulations

■ Access to the battery

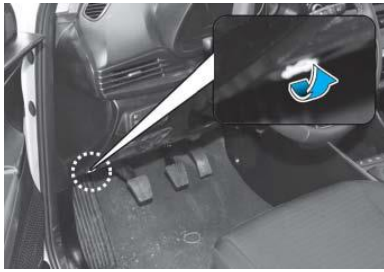
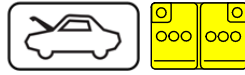

Pull the release lever to unlatch the hood. The hood should pop open slightly.

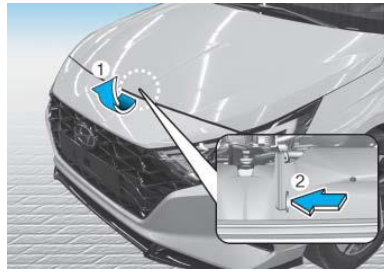

Raise the hood slightly, push the secondary latch up (1) inside of the hood center and lift the hood (2)

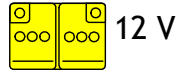

■ Disabling procedure

① Turn the ignition switch off



② Disconnect the negative(-) terminal



③ Disconnect the positive(+) terminal

4. Access to the occupants

■ Glass

1 : Laminated
2-5 : Tempered



■ Vehicle body

Hardened Steel

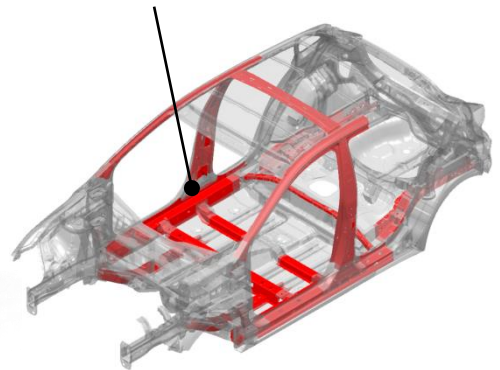

5. Stored energy / liquids / gases / solids

■ Fuel Tank

40ℓ

■ Battery

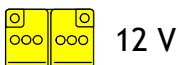

ID No.	Version No.	Version date	Page
NLH-BC3-RSI-01-202104	01	04/2021	3 of 4

6. In case of fire

■ Gas Strut



- Risk of missile effect of tailgate.

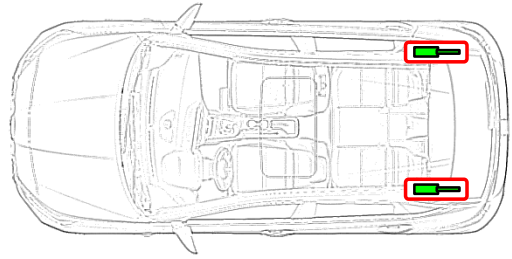

8. Towing / transportation / storage

■ OK

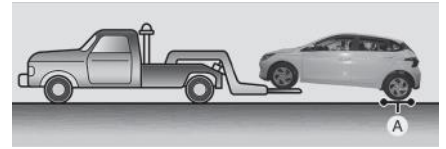
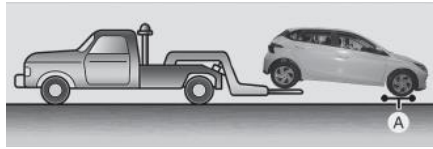
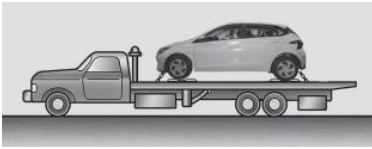

[A] : Dolly

■ NOT OK



	ID No.	Version No.	Version date	Page
	NLH-BC3-RSI-01-202104	01	04/2021	4 of 4