

AUDIO & NAVIGATION SYSTEM

OWNER'S MANUAL

ix20

Please read this manual carefully before operating your set and retain it for future reference.
Designs and specifications are subject to change without prior notice.



Table of contents

General information 7-10

Safety notes	7-8
Types of Playable Discs	9
Precautions of handling discs and player	9
NOTES ON COPYRIGHTS	10
Disposal of your old appliance	10

Name of each component 11-13

Control Panel	11-12
Steering wheel remote control	13

Basic operation 14-15

Start-up screen	14
Turning the unit on/ Turning the unit off	14
Inserting a disc/ Ejecting a disc	14
Adjusting the volume	14
Selecting a source on the control panel	15
Selecting a source on the screen	15
Rear view camera (Optional)	15

Setup 16-19

General operations of SETUP menu	16-19
Bluetooth	16
System	16-17
Traffic/ Navigation	18
Audio	18-19
Display	19

Table of contents

Getting started with navigation. 20-21

What is GPS?	20
About satellite signals	20
Acquiring satellite signals	20
Initial navigation screen	20
Indicators of the map screen	20-21
How to view a map screen	20-21
Changing the scale of a map	21
Adjusting the navigation volume	21

Destination input menu 22-32

Navigation menu overview	22
General operations of destination menu	22
Address Search	23
Last destinations	24
Address book	24
POI (Point of Interest)	24-26
Near position	25
Near destination	26
In City/ Name	26
Hyundai service	26
Phone number	26
GPS input	27
Parking	28
Continue guidance/ Stop guidance	28
Using map	28
Tour planner	29-30
Store destination	31
Store position	31
Home 1/ Work 2/ 3 ~ 12	32

Table of contents

Using the map menu33-38

Map menu overview	33
General operations of map menu	33
POI category	34
2D/ 3D	34
Split screen/ Full screen	35
Store position	35
Tour planner	35
Route options	36
Browser	37
Detour	37
Info nearby	38
Info on route	38

Bluetooth wireless technology39-46

Understanding Bluetooth wireless technology	39
Connecting your unit and bluetooth phone	39-40
Viewing the connected bluetooth phone	41
Disconnecting/Connecting again the bluetooth phone	41
Deleting a connected phone	41-42
Changing the passkey	42
Making a call by entering phone number	42
Switching the sound path during a call	42
Switching the microphone on/off	42
Answering calls	43
Using your Phone Book	43-44
Using your Calling list	44
Making a call with speed dial numbers	45
Activating the audio streaming mode	46

Table of contents

CD/MP3/WMA/USB/iPod operation47-52

Playing an audio CD and MP3/ WMA/ USB/ iPod files	47-49
Skip to the next track/file	47
Skip to the previous track/file	47
Return to the beginning of the current track/file	47
Search.	47
Intro scan	48
Repeat	48
Random	49
Playing files by classifying into folder/ Album/ Artist	49
Locating a folder/file using the list	50
Searching music	50
Setting audio book play speed.	51
USB device requirement/ Compatible USB devices	51
MP3/WMA file requirement	52
iPod device requirement.	52

Radio operation53-55

Listening to the radio stations	53
Storing and recalling stations.	53
AS (Autostore).	54
To scan broadcast frequencies.	54
TA (Traffic announcement)	54
NEWS.	55
Region auto/Off.	55

Auxiliary device operation56

Using an AUX source/ Adjusting the video screen	56
-----------------------------------------------------------	----

Table of contents

Voice recognition system57-61

Voice recognition	57
Giving voice commands	57
How to say numbers	57
Voice command examples	58-59
Help command	59
Voice commands	60-61



Troubleshooting62-63

Index64

Symbols for the display of traffic problems.65

General information

Safety notes

	CAUTION RISK OF ELECTRIC SHOCK DO NOT OPEN	
CAUTION : TO REDUCE THE RISK OF ELECTRIC SHOCK DO NOT REMOVE THE COVER(OR BACK) NO USER SERVICEABLE PARTS INSIDE. REFER SERVICING TO QUALIFIED SERVICE PERSONNEL.		



The lightning flash with the arrowhead symbol, within an equilateral triangle is intended to alert the user about the presence of uninsulated dangerous voltage within the product's enclosure that may be of sufficient magnitude to constitute a risk of electric shock.



The exclamation point within an equilateral triangle is intended to alert the user to the presence of important operating and maintenance (servicing) instructions in the literature accompanying the appliance.



Always operate the vehicle in a safe manner. Do not become distracted by the vehicle while driving, and always be fully aware of all driving conditions. Do not change settings, or any functions. Pull over in a safe and legal manner before attempting such operations. To promote safety, certain functions are disabled unless the hand break is on.



Do not use for many hours at extremely low or high temperature. (-10 °C to 60 °C)



To reduce the risk of electric shock, do not remove the cover or back of this product. There are no user-serviceable parts inside. Refer servicing to qualified service personnel.



To reduce the risk of fire or electric shock, do not expose this product to dripping or splashing water, rain, or moisture.



The temperature of unit's outside can be extremely high, please use the unit after proper installation in your vehicle.



While driving, keep the sound volume at a proper level.



Do not drop it and avoid heavy impacts at anytime.

General information



The driver must not watch the monitor while driving. If the driver watches the monitor while driving, it may lead to carelessness and cause an accident.



This unit is for vehicles with a 12 V battery and negative grounding. Before installing it in a recreational vehicle, lorry or bus, check the battery voltage. To avoid shorts in the electrical system, be sure to disconnect the  battery cable before beginning the installation.

CAUTION :

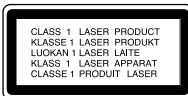

This product uses a Laser System. To ensure proper use of this product, please read this owner's manual carefully and retain it for future reference. Should the unit require maintenance, contact an authorized service center. Performing controls, adjustments, or carrying out procedures other than those specified herein may result in hazardous radiation exposure. To prevent direct exposure to laser beam, do not try to open the enclosure. Visible laser radiation when open. DO NOT STARE INTO BEAM.

CAUTION :

CLASS 1M VISIBLE AND INVISIBLE LASER RADIATION WHEN OPEN DO NOT VIEW DIRECTLY WITH OPTICAL INSTRUMENTS.

CAUTION :

- Do not keep the navigation system running with the engine stopped. Doing so may discharge the vehicle battery. When you use the navigation system, always keep the engine running.
- When the driver wants to operate the navigation system, first park the vehicle in a safe location and set the parking brake. Operating the system while driving can distract the driver and may result in a serious accident.
- Do not disassemble or modify this system. If you do, it may result in accidents, fire or electrical shock.
- Some country may have laws limiting the use of video screens while driving. Use the system only where it is legal to do so.
- Don't use your phone when you are driving. You must stop at a safe place to use your phone.
- When driving your vehicle, be sure to keep the volume of the unit low enough to allow you to hear sounds coming from the outside.

General information

Types of Playable Discs

This unit plays CD-R or CD-RW containing audio titles, MP3 or WMA files.

- Depending on the conditions of the recording equipment or the CD-R/RW disc itself, some CD-R/RW discs cannot be played on the unit.
- Do not attach any seal or label to either side (the labeled side or the recorded side) of a disc.
- Do not use irregularly shaped CDs (e.g., heart-shaped or octagonal). It may result in malfunctions.

Precautions of handling discs and player



- A defective or soiled disc inserted into the unit can cause sound to drop during playback.
- Handle the disc by holding its inner/outer edges.
- Do not touch the surface of the unlabeled side of the disc.



- Clean the disc before playback. Wipe the disc from the center outward with a cleaning cloth.
- Never use solvents such as benzene or alcohol to clean the disc.



Do not stick paper or tape etc. on the surface.



Do not expose the disc to direct sunlight or excessive heat.



This unit cannot play 8 cm disc (use 12 cm disc only).

General information

NOTES ON COPYRIGHTS

It is forbidden by law to copy, broadcast, show, broadcast via cable, play in public, or rent copyrighted material without permission.

This product features the copy protection function developed by Macrovision. Copy protection signals are recorded on some discs. When playing the pictures of these discs on a unit, picture noise will appear. This product incorporates copyright protection technology that is protected by method claims of certain U.S. patents and other intellectual property rights owned by Macrovision Corporation and other rights owners. Use of this copyright protection technology must be authorized by Macrovision Corporation, and is intended for home and other limited viewing uses only unless otherwise authorized by Macrovision Corporation. Reverse engineering or disassembly is prohibited.

Disposal of your old appliance



1. When this crossed-out wheeled bin symbol is attached to a product, it means the product is covered by the European Directive 2002/96/EC.
2. All electrical and electronic products should be disposed of separately from the municipal waste stream via designated collection facilities appointed by the government or the local authorities.
3. The correct disposal of your old appliance will help prevent potential negative consequences for the environment and human health.
4. For more detailed information about disposal of your old appliance, please contact your city office, waste disposal service or the shop where you purchased the product.



iPod is a trademark of Apple Inc., registered in the U.S. and other countries. "Made for iPod" means that an electronic accessory has been designed to connect specifically to iPod and has been certified by the developer to meet Apple performance standards.



"The Bluetooth word mark and logos are owned by the Bluetooth SIG, Inc. and any use of such marks by LG Electronics is under license. Other trademarks and trade names are those of their respective owners."

Name of each component

Control Panel

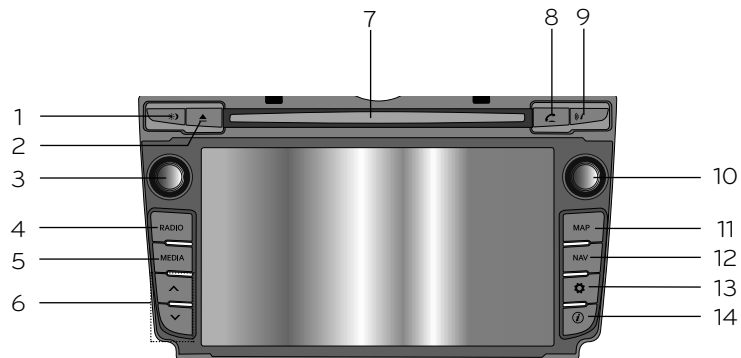

1. Display on/off (⏻)

Press to switch between the display on and off.

2. Eject (⏏)

Press to eject a disc from the unit.

3. Left rotary (⏻ / ⏮)

- Press: Power on/off
- Turn: Volume control

4. RADIO

Selects the FM/AM band.

5. MEDIA

Selects a source: CD, USB, iPod, BT, AUX.

6. ^ / v

- Press this button.
 - Automatic tuning: RADIO
 - Track up/down: USB CD iPod
 - BT
- Press and hold this button.
 - Search (FF/REW): USB CD
 - iPod BT

7. Disc slot

Name of each component

8. PHONE (☎)

Use to enable Bluetooth Hands-Free Phone.

9. Repeat voice guidance (🔊)

Press to repeat the voice guidance.

10. Right rotary (↻)

Rotate it clockwise/counterclockwise.

- Searches the previous or next radio frequency.
 - Manual tuning
- Skips a track/file up/down in all list screen.
- ZOOM IN/ ZOOM OUT
 - Rotate to change the map scale on the map screen.

11. MAP

Press to display the current location map screen.

12. NAV

Press to enter a destination menu. Various methods for entering a destination are available.

13. SETUP (⚙)

- Press to access system settings. (Page 16)

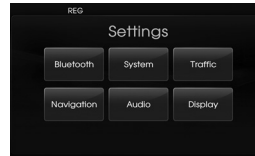

- Press and hold to check the device ID, the software version, the navigation version, and the map version.

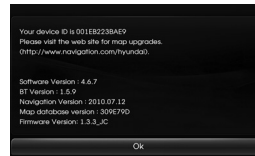

14. Info (ℹ)









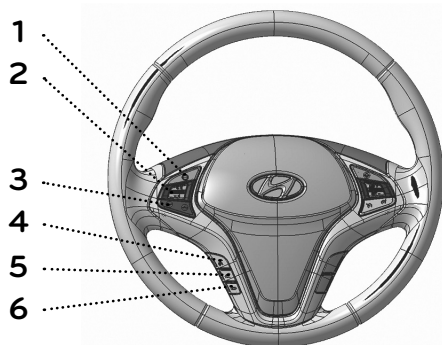

Press to view the destination, route, and traffic information when the route guidance is active.



- Destination: Shows the information of current vehicle position and destination.
- Route: Shows the route information from the current vehicle position to the destination.
- Traffic: Shows the traffic information.
 - Traffic info on route: The list of traffic information found on the recommended route from the current vehicle position to the destination is displayed.
 - Traffic info nearby: The list of traffic information around the current vehicle position is displayed.

Name of each component

Steering wheel remote control



- 1. 
Selects a source.
FM → AM → CD → USB → iPod
→ BT → AUX → FM...
- 2. **Volume (+/-)**
Increases or decreases the volume level.
- 3. **Λ / V**
 - Press this button.
 - Automatic tuning: 
 - Track up/down:   
 - 
 - Press and hold this button.
 - Manual tuning: 
 - Search (FF/REW):   
 - 

- 4. 
 - Press this button to start the voice recognition mode.
 - Press the button one more to cancel voice commands while the voice recognition is active.
- 5. 
Enables Bluetooth Hands-Free Phone.
 - Press this button briefly to take a call when there is an incoming call.
 - Press this button briefly to make a call from last calls.
 - Press this button lengthily to switch the sound path during a call. (Hands free ↔ phone)

- 6. 
Press this button briefly to reject a call during a call.

Basic operation

Start-up screen

The unit starts when the ignition switch is placed in the ACC or ON position.



- Then the radio mode is displayed on the screen.

* Note

- The unit memorizes the last mode that is played lastly. The last mode is saved in the memory even if the ignition switch is placed in the OFF position. When the ignition switch is placed in the ACC or ON position, the mode is automatically recalled.
- It may take long time (about 20 seconds) for the unit to be rebooted.

Turning the unit on

Press  on the control panel in power off status.

* Note

When you insert the disc in the disc slot, the unit is turned on automatically.

Turning the unit off

Press  on the control panel in power on status.

Inserting a disc

Insert a disc in the disc slot and play-back starts automatically.

Ejecting a disc

Press  on the control panel.

The disc is ejected from the loading slot.

* Note

If the ejected disc is not removed in approximately 10 seconds, the disc is automatically inserted again into the loading slot.

Adjusting the volume

Rotate the volume knob () on the control panel.

* Note

When you turn the unit off, the current volume level is automatically memorized. Whenever you turn the unit back on, it operates at the memorized volume level.

If you turn the unit off/on below volume level 5, the volume level is changed into 5. If you turn the unit off/on above volume level 25, the volume level is changed into 25.

Basic operation

Selecting a source on the control panel

Press MEDIA repeatedly to select a source.

The mode switches as follows.

CD → USB → iPod → BT → AUX → CD...

* Note

If a source is not connected to the unit, the source is not recognized.

Selecting a source on the screen

You can select the source on the screen to make it operate according to your particular needs.

1. Touch the source icon in the left upward position when playing a source.

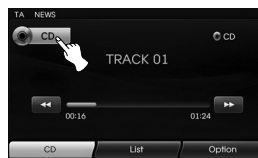

2. Touch the desired source.

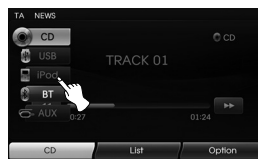

* Note

If a source is not connected to the unit, the source is not recognized.

Rear view camera (Optional)

With a rear view camera, automatic switching to video from a rear view camera is possible when the gearshift is moved to **REVERSE (R)** position. Rear view mode also allows you to check what is behind you while driving.

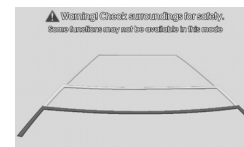

When the unit is booted completely, the guide line is displayed on the screen.

* Note

- The rear view camera function is to use this product as an aid to keep an eye on trailers, or backing into a tight parking spot. Do not use this function for entertainment purposes.
- The object in rear view may appear closer or more distant than in reality.
- Please note that the edges of the rear view camera images may differ slightly according to whether full screen images are displayed when backing.

Setup

General operations of SETUP menu

The navigation system can be customized to make it easier for you to use: Bluetooth, System, Traffic, Navigation, Audio, Display

1. Turn the unit on.
2. Press  on the control panel.

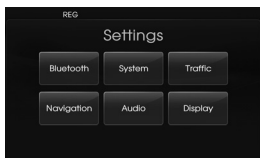

3. Touch the desired option.
4. Touch the desired settings then touch [Ok] to confirm your selection.

* Note

Touch  to return to the previous screen. Press MAP to return to the current location map screen.

Bluetooth

There are four kinds of screen menus.



View Bluetooth device list

This allows you to view the paired Bluetooth device list.

Search for Bluetooth devices

This allows you to search for Bluetooth devices. (Page 39)

External device authorization

This allows you to use when you connect your unit and bluetooth phone by using your bluetooth phone settings. (Page 40)

Change passkey

You can change the passkey. (Page 42)

System



There are five kinds of screen menus.



Language

This allows you to change the language used in the system.



Touch the language button you want. Use  or  to scroll up or down if necessary.

Setup

Clock

This allows you to set the time format and the summer time.



- Time format: Change the time format between the "12h" and "24h".
- Summer time: Set the summer time between the "On" and "Off".
The unit sets the clock automatically by detecting the summer time whether it is the summer time season or not. Even though the summer time is set to "On", the unit sets the clock to normal time (not +1 hour) when it's not summer time season.

Units

This allows you to set the unit of distance displayed on your navigation system.



Change the unit between the "km" and "mls".

Navigation demo

This is a demonstration function. After a route is set, a simulation of route guidance to a destination is automatically displayed.



- Navigation demo
 - Off: Demo mode is set off.
 - 1x: Sets the demo drive only once.
 - Loop: Repeat demo drive
- Speed: Sets the speed of demo drive.

Factory settings

This allows you to initialize various settings to the default settings.



- All: Initializes all the settings to the default settings.
- Phone: Initializes all the settings related with phone.
- Navigation: Initializes all the settings related with navigation.
- Audio/Media/Radio: Initializes all the settings related with Audio/ Media/ Radio.

Setup

Traffic

There are three kinds of screen menus.



TMC

Change the TMC (Traffic Message Channel) to "Off", "Auto" or "On".

- Auto: When the TMC event is found on current route, the navigation system searches the detour route automatically without any announcement.
- Off: Cancels the TMC function.
- On: When the TMC event is found on current route, the navigation system displays the pop-up screen of the event information.

Automatic TMC station

When the TMC event is found on current route, the strongest TMC station is received automatically.

Favourite TMC station

The unit receives the TMC station that the user set. This is activated when you cancel the [Automatic TMC station].

Navigation

There are five kinds of screen menus.



Motorway junction view

This displays the motorway junction on the map screen.

Enhanced lane guidance

This displays the enhanced lane on the map screen.

Plan different routes

This displays the plan different routes on the map screen.

Speed alert

This displays the speed alert on the map screen.

Dynamic guidance

This guides road numbers, road names, direction, or etc in TTS (Text-to-Speech) voicing system.

Audio

There are five kinds of screen menus.



SDVC (Speed Dependent Volume Control)

When the speed of your vehicle is more than 40 km/h, the volume level outputs higher than original volume level. You can set the SDVC to Off, Low, Mid (Middle), or High.

- Off: Outputs the original volume level regardless of the speed of your vehicle.
- Low, Mid, High: This outputs automatically the volume level according to the speed of your vehicle.

Navigation volume

You can set or cancel the voice announcement for navigation. Even though the setting is "Off", when starting new route guidance, it is set to "On" automatically.

Touchscreen click

You can set the touchscreen sound to On/Off.

Setup

Sound (Default : Center)

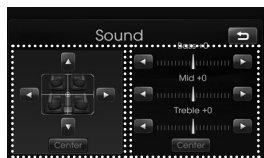

Balance/
Fader

Bass/Mid/
Treble

- Balance: Touch ◀ or ▶ to adjust the sound the left and right speakers.
- Fader: Touch ▲ or ▼ to adjust the sound of the front and rear speakers.
- Bass, Mid, Treble: Touch ◀ or ▶ to adjust the Bass, Middle or Treble.

* Note

Touch [Center] to return to the default settings.

Power bass

You can set the Power bass to Off, Low, Mid (Middle), or High.



- Off: Outputs the original sound.
- Low, Mid, High: Set the Low, Mid (Middle), or High to boost the low-pitched sound.

Display

There are two kinds of screen menus.



Brightness

You can set the brightness of the screen.

Set the display brightness to Low, Mid (Middle), or High.

Map mode

To improve the visibility of the map screen between day and night, you can change the combination of the colours of the map.

- Auto: The map screen is displayed by autolight signal or illumination signal.

	Illumination On	Illumination Off
Autolight Off (Day)	Map: Day	Map: Day
Autolight On (Night)	Map: Night	Map: Night
Autolight is not detected	Map: Night	Map: Day

- Day: The map screen is always displayed with bright colours.
- Night: The map screen is always displayed with dark colours.

Getting started with navigation

What is GPS?

The Global Positioning System (GPS) is a satellite-based navigation system made up of a network of 24 satellites placed into orbit by the U.S. Department of Defense.

Department of Defense.

GPS was originally intended for military applications, but in the 1980s, the government made the system available for civilian use.

GPS works in any weather conditions, anywhere in the world, 24 hours a day. There are no subscription fees or setup charges to use GPS.

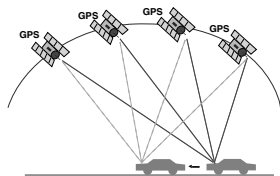

About satellite signals

Your unit must acquire satellite signals to operate. If you are indoors, near tall buildings or trees, or in a parking garage, the unit cannot acquire satellites.

Acquiring satellite signals

Before the unit can find your current location and navigate a route, you must do the following steps:

1. Go outside to an area free from tall obstructions.
2. Turn on the unit.

Acquiring satellite signals can take a few minutes.

Initial navigation screen

After the ignition switch is placed in the ACC or ON position, when you enter a navigation mode for the first time, the caution screen is displayed on the screen. Read the caution carefully and then touch [Agree].

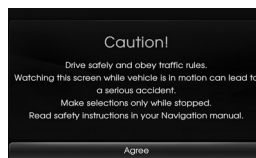

Indicators of the map screen

How to view a map screen

The navigation system displays various information on the screen.



Indicates the direction of the map. Touch to switch the orientation of the map.



Indicates the current vehicle location and the direction of travel.



Touch [Menu] to access the map menu.

Getting started with navigation



Indicates the scale of the map.



Indicates the arriving time, distance and remaining time to the destination.



Appears on the upper right corner of the screen when a route is set. Indicates the distance to the next guide point and the turning direction at that guide point.



Indicates the speed limit on the road that you're driving now.

Changing the scale of a map

1. Touch  on the map screen.



2. Touch [+] to view the map in detail. Touch [-] to view the map a wider area.



50 m ↔ 100 m ↔ 200 m ↔ 300 m ↔ 500 m ↔ 750 m ↔ 1 km ↔ 2 km ↔ 5 km ↔ 10 km ↔ 20 km ↔ 50 km ↔ 100 km ↔ 200 km ↔ 500 km

3. If you want to set the auto zoom, touch .

Adjusting the navigation volume

If you want to adjust the navigation volume, follow the below method.

Method 1

Rotate the volume knob (▲) on the control panel or press the volume (+▲ / -▲) on the steering wheel remote control during the voice guidance.

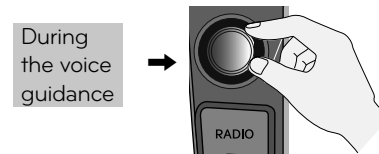

Method 2

If you want to adjust the navigation volume, rotate the volume knob (▲) on the control panel or press the volume (+▲ / -▲) on the steering wheel remote control during the voice guidance after pressing  on the control panel.

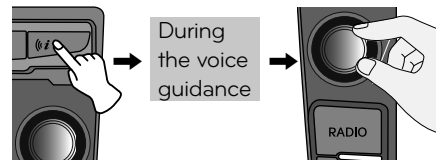

Destination input menu

Navigation menu overview

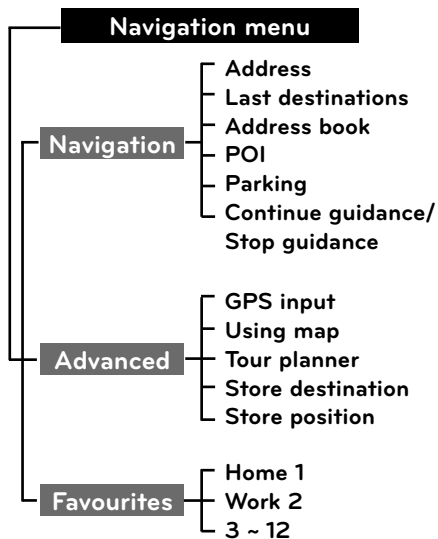

General operations of destination menu

1. Turn the unit on.
2. Press NAV on the control panel. The navigation menu appears on the screen.
3. Touch [Navigation], [Advanced] or [Favourites] or

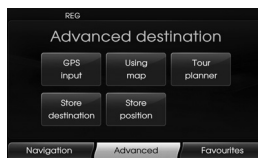

[Advanced] menu



[Favourites] menu

4. Touch the preferred setting method.
 - Address: Finds a destination by setting an address. (Page 23)
 - Last destinations: Sets a destination to a location that you have lastly set. (Page 24)
 - Address book: Sets a destination to a location stored in the Address book. (Page 24)
 - POI: Searches for a destination from various categories of businesses or locations. (Page 24-26)
 - Parking: Sets a parking as your destination. (Page 28)
 - Continue/Stop guidance: Sets the guidance to On/Off. (Page 28)
 - GPS input: Sets a latitude and a longitude as your destination. (Page 27)
 - Using map: Searches for a destination by scrolling the map. (Page 28)
 - Tour planner: Adds new destination or way point. (Page 29-30)
 - Store destination: Stores your destination in the Address book. (Page 31)
 - Store position: Stores your position in the Address book. (Page 31)
 - Home 1/ Work 2/ 3 ~ 12: You can set a home location, work location or etc you want for the place you return to most often. (Page 32)

Destination input menu

Address Search

You can find the destination by searching the address.

1. Press [NAV] > Touch [Address].

2. Set the preferred country.
If the country has already been set, follow the step 3.



3. Set the preferred city name and then touch [Ok].



4. Touch the city in the list.



5. Set the part characters of street name and then touch [Ok].



6. Touch the street in the list.



7. Touch the house number and then touch [Ok].



8. Set the route options and then touch [Ok].



Refer to the "Route options" on the page 36.

9. Touch [Start].



- If you want to store your destination in the Address book, touch [Store]. And input the name of your destination then touch [Ok].
- If you want to view the map of your destination, touch [Show map] then [Start].

10. Touch the preferred route, then touch [Start]. Refer to the Note regarding route criteria on the page 36.

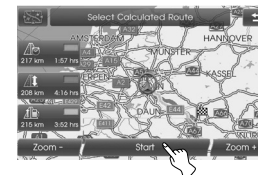

Drive in accordance with the screen and voice information.

Destination input menu

Last destinations

You can find the destination to a location that you have lastly set as the destination. Up to 50 Last destinations are automatically stored. If the number of Last destinations exceed 50, the oldest one is replaced by the new one.

1. Press [NAV] > Touch [Last destinations].
2. Touch the preferred last destination from the list.

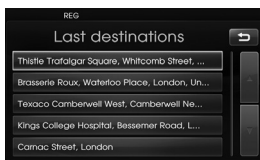

3. Touch the preferred route, then touch [Start].

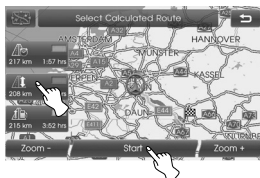

Drive in accordance with the screen and voice information.

Address book

You can find the destination to a location stored in the Address book. To utilize this function more effectively, destinations that you often travel to should be stored in advance.

First of all, store in the Address book by searching the address. Refer to the Address Search on the page 23.

1. Press [NAV] > Touch [Address book].
2. Touch the preferred destination from the list.

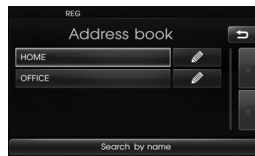

3. Touch the preferred route, then touch [Start].

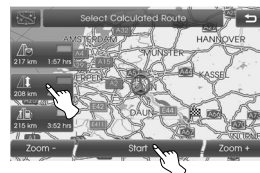

Drive in accordance with the screen and voice information.

POI (Point of Interest)

You can find a destination from various categories of businesses or locations.

1. Press [NAV] > Touch [POI].
2. Touch one of the main category.

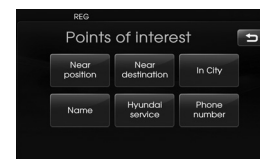

- Near position: Sets a POI located near the current vehicle position. (Page 25)
- Near destination: Sets a POI located near the selected destination. (Page 26)
- In City: Sets a POI located in the city. (Page 26)
- Name: Sets a POI by the name of the facility. (Page 26)
- Hyundai service: Sets a facility of the Hyundai service. (Page 26)
- Phone number: If you know the telephone number of the facility, use this to find the entering the number. (Page 26)

Destination input menu

Near position

1. Press [NAV] > Touch [POI] > [Near position].
2. Touch one of the subcategory. (For example: Emergency)



3. Touch one of the subcategory in next level. (For example: Hospital)



4. Touch the preferred POI.



5. Touch [Ok] after confirming the location of the displayed POI.

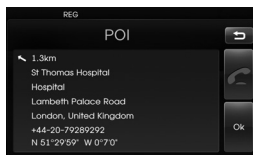

If you want to call on the telephone, touch . It is available only when the bluetooth is active.

6. Touch [Start].



7. Touch the preferred route.

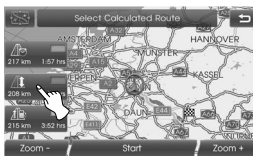

8. Touch [Start].

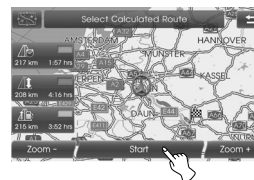

Drive in accordance with the screen and voice information.

Destination input menu

Near destination

1. Press [NAV] > Touch [POI] > [Near destination].
2. Follow steps 2-8 on the page 25 (Near position).

In City

1. Press [NAV] > Touch [POI] > [In City].
2. Set the part characters of city name and then touch [Ok].



3. Touch the city in the list.

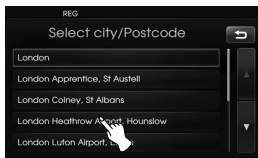

4. Follow steps 2-8 on the page 25 (Near position).

Name

1. Press [NAV] > Touch [POI] > [Name].
2. Set the preferred country.
3. Input the part characters of the facility name and then touch [Ok].



4. Follow steps 4-8 on the page 25 (Near position).

Hyundai service

1. Press [NAV] > Touch [POI] > [Hyundai service].
2. Follow steps 4-8 on the page 25 (Near position).

* Note

The information of position may differ from actual location due to some changes of dealership and dealer location information.

Phone number

1. Press [NAV] > Touch [POI] > [Phone number].
2. Input the phone number and then touch [Ok].



3. Touch the preferred phone number from the list.
4. Touch [Ok] after confirming the location of the displayed POI.

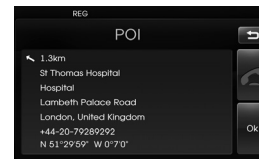

If you want to call on the telephone, touch [Phone]. It is available only when the bluetooth is active.

5. Follow steps 6-8 on the page 25 (Near position).

Destination input menu

GPS input

You can find the destination by inputting the coordinates of latitude and longitude.

1. Press [NAV] > Touch [Advanced] > [GPS input].
2. Touch [Latitude].



3. Input the coordinates of latitude by touching the degree. (For example: 49°)

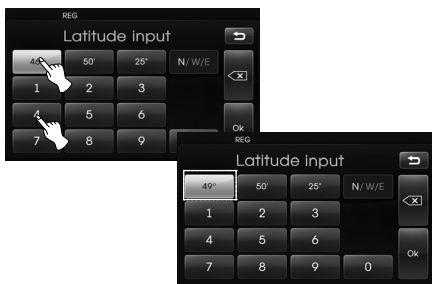

4. Input the coordinates of latitude by touching the minutes. (For example: 58')

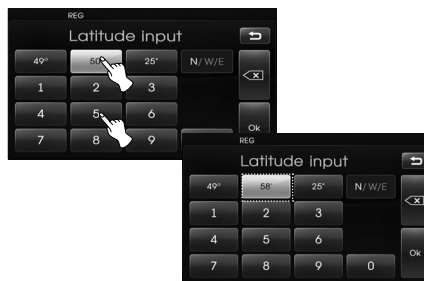

5. Input the coordinates of latitude by touching the seconds. (For example: 29'')

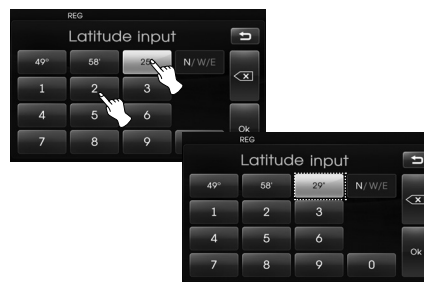

6. Touch [Ok].



7. Input the coordinates of longitude. Refer to the steps 2-6. (For example: 8°, 42', 31'')

8. When the settings are completed, touch [Start].



9. Follow steps 7-8 on the page 25 (Near position).

* Note

If you make a mistake while touching, touch  to erase one digit at a time.

Destination input menu

Parking

You can find the destination by searching the parking facility.

1. Press [NAV] > Touch [Parking].
2. Touch a preferred facility.



3. Follow steps 4-8 on the page 25 (Near position).

Continue guidance/ Stop guidance

If you no longer need to travel to your destination or if you want to change your destination, press [NAV] > touch [Stop guidance]. If you continue to travel to your destination again, touch [Continue guidance].

Using map

This allows you search for a destination by scrolling the map.

1. Press [NAV] > Touch [Advanced] > [Using map].
2. Scroll the map, place the cross pointer over the preferred location.



3. Touch [Start].

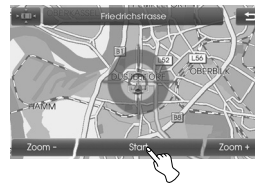

4. Touch the preferred route, then touch [Start].

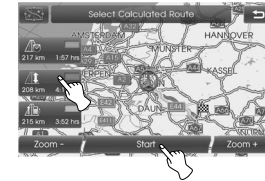

Drive in accordance with the screen and voice information.

Destination input menu

Tour planner

The Tour planner allows you to travel through the searched routes by setting a destination or way point.

You can set a total of 4 destination or way point.

- New tour: Sets a tour.
- Load tour: Displays the tourist.
- Show tour: Displays tourist set lastly.

Setting a tour

1. Press [NAV] > Touch [Advanced] > [Tour planner].

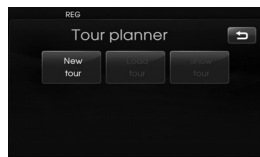

2. Touch [New tour].

3. Touch [Yes].



4. Set a destination by using the navigation menu.
(Refer to the page 22.)
The destination you set is displayed.



5. Touch [Add tourpoint].



6. Set a way point by using the [Navigation], [Advanced], and [Favourites] menu.
(Refer to the page 22.)



If you need an additional way point, set it by touching [Add tourpoint] again.

7. Touch [Start].
If you would like to save the searched routes, touch [Yes].
Otherwise, touch [No].

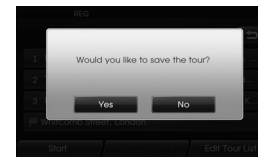

8. Input a name, then touch [Ok].



The searched routes are stored in the [Load tour] automatically.

9. Drive in accordance with the screen and voice information.

Destination input menu

Editing/deleting a destination or way point

You can modify or delete the destination or way point already set.

1. Press [NAV] > Touch [Advanced] > [Tour planner] > [Load tour].
2. Touch the desired tourist.

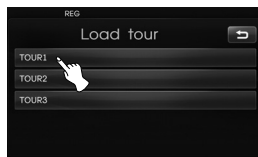

3. Touch [Edit tour list].

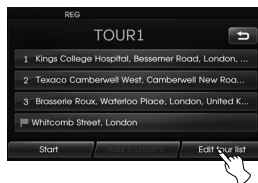

4. Touch the desired options.

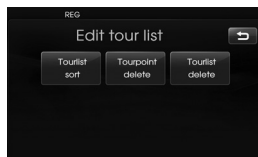

[Tourist sort]: Changes the order of the destination and way point already set. (Follow Steps 5-6)

[Tourpoint delete]: Deletes the way point. (Follow Steps 7-9)

[Tourist delete]: Deletes the tourist. (Follow Steps 10-11)

5. Touch [Tourist sort] and then touch [Ok] after changing the order.

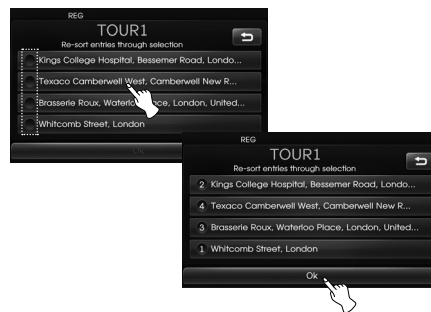

6. Follow steps 7-9 on the page 29 (Setting a tour).

7. Touch [Tourpoint delete] to delete the way point.

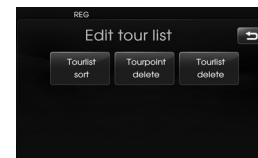

8. Touch the desired way point.

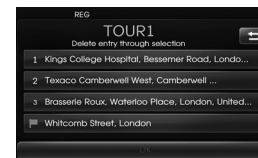

9. Follow steps 7-9 on the page 29 (Setting a tour).

10. Touch [Tourist delete] to delete the tourist you set.

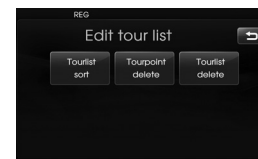

11. Touch the desired tourist.

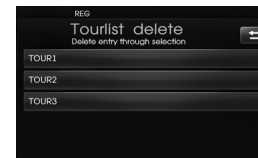

Destination input menu

Store destination

Destinations that you often visit can be stored in the Address book. The stored destinations can be easily retrieved to set them as a destination or way point. This is available only when the destinations have been set already.

1. Press [NAV] > Touch [Advanced] > [Store destination].
2. Input the name of the destination then touch [Ok].

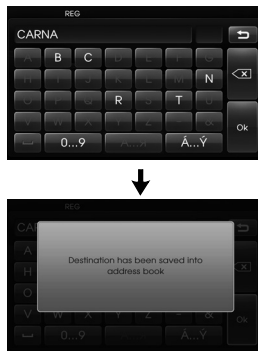

The destination is stored in the Address book automatically. (Page 24)

Store position

The current vehicle position can be stored in the Address book.

1. Press [NAV] > Touch [Advanced] > [Store position].
2. Input the name of the current position then touch [Ok].

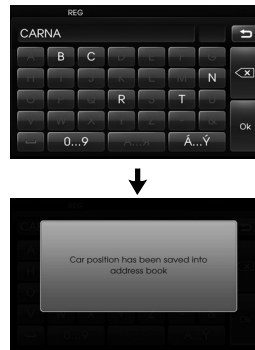

The current vehicle position is stored in the Address book automatically. (Page 24)

Destination input menu

Home 1/ Work 2/ 3 ~ 12

If your home location, work location and favourite locations are already stored in the Address book, it can be easily retrieved to set the route to your home location, work location and favourite locations.

Storing your home

1. Press [NAV] > Touch [Address book].
2. Touch  after confirming the preferred location.



3. Touch [Favourites].



4. If you want to set the location to your home, touch [1 Home].



5. Touch [Ok].



* Note

- The procedure to store your work location and favourite locations is same as the one for storing your home.
- New information placed in the same storage position overwrites the old data.
- If you want to delete the location stored in the Address book, touch [Delete].
- If you want to store the current location in [Favourites] menu, press [NAV] > touch [Favourites] > touch and hold the preferred number > Input a name, then touch [Ok].

Finding your home

1. Press [NAV] > Touch [Favourites].

2. Touch [Home 1].



3. Touch the preferred route, then touch [Start].

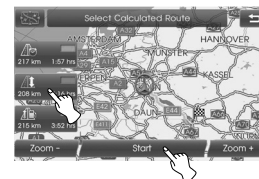

Drive in accordance with the screen and voice information.

* Note

The procedure to find your work location and favourite locations is same as the one for finding your home.

Using the map menu

Map menu overview

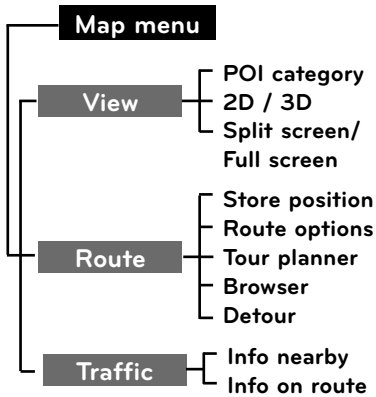

General operations of map menu

1. Turn the unit on.
2. Press MAP. The map screen appears.
3. Touch [Menu].



4. Touch [View], [Route] or [Traffic] to select the desired option.

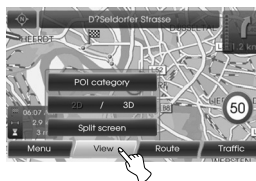

[View] menu



[Route] menu



[Traffic] menu

5. Touch the preferred setting method. For details, refer to the page 34-38.

Using the map menu

POI category

Some landmarks in the surrounding area can be displayed as icons on the screen.

This allows you to display or hide the landmark icons by type.

1. Press [MAP] > Touch [Menu] > [View] > [POI category].



2. Touch the desired icons.
The icon display settings toggle on and off each time you touch the icon. The indicator of the selected icon illuminates.



3. Touch [OK].

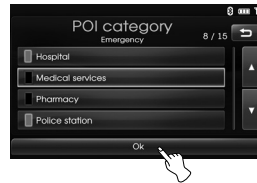

The activated landmark icons are displayed on the map.

2D/ 3D

The map view can be changed between 2D and 3D.

- 2D: Displays the map in a 2-dimensional environment similar to a road map.
- 3D: Displays the view from an elevated perspective. It is easy to recognize an image of the route because it provides a panoramic view over a long distance.

1. Press [MAP] > Touch [Menu] > [View] > [2D/3D].



2. Touch [2D/3D] again to switch to the 2D screen.

Using the map menu

Split screen/ Full screen

The map view can be changed between split screen and full screen.

1. Press [MAP] > Touch [Menu] > [View] > [Split screen].



Split screen

2. To switch to the full screen mode, touch [Menu] > [View] > [Full screen].

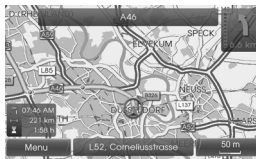

Full screen

Store position

The current vehicle position can be stored in the Address book.

1. Press [MAP] > Touch [Menu] > [Route] > [Store position].



2. Input the name of the current position then touch [Ok].

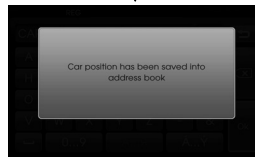

The current vehicle position is stored in the Address book automatically. (Page 24)

Tour planner

The Tour planner allows you to travel through the searched routes by setting a destination or way point.

1. Press [MAP] > Touch [Menu] > [Route] > [Tour planner].



2. Refer to "Tour planner" on the pages 29-30.

Using the map menu

Route options

You can modify the route conditions or confirm the route information. Set the appropriate route condition according to your purpose.

1. Press [MAP] > Touch [Menu] > [Route] > [Route options].



2. Touch the preferred setting item.
 - Route: If you don't set the [Plan different routes] in the setup menu, set the route option to fast (🚗), short (🚚) or eco (🚗).

* Note

- Fast Route: Calculates a route with the shortest travel time.
- Short Route: Calculates a route with the shortest distance.
- Eco (Economical) Route:
 - To save fuel consumption, this route considers to reduce the number of frequent stop&go route at the intersection and turn-

ing point based on fuel consumption table with real time traffic information, however this route may not be valid in terms of driving conditions such as sudden acceleration.

- Eco Route might have more driving time and distance to save fuel consumption.
- TMC:
 - auto (🚗): When the TMC event is found on current route, the navigation system searches the detour route automatically without any announcement.
 - off (🚗): Cancels the TMC function.
 - on (🚗): When the TMC event is found on current route, the navigation system displays the pop-up screen of the event information.

* Note

A pay TMC is not supported.

- Toll Road (🚗)
 - use: Includes the use of toll roads.
 - avoid: Enables the avoid of toll roads.
- Tunnel (🚗)
 - use: Includes the use of tunnel.
 - avoid: Enables the avoid of tunnel.
- Main Road (🚗)
 - use: Includes the use of main road.
 - avoid: Enables the avoid of main road.
- Ferry (🚗)
 - use: Includes the use of ferries.
 - avoid: Enables the avoid of ferries.

3. Press [Ok].

When the current location map screen or route setting screen is displayed, the system recalculates a route with the set conditions.

* Note

- Always stop the vehicle in a safe local before modifying the route conditions.
- Modifying the route conditions while driving may cause an accident.

Using the map menu

Browser

You can view an enlarged screen of route section when the route guidance is active.

1. Press [MAP] > Touch [Menu] > [Route] > [Browser].



2. Touch [Previous] or [Next] to view the route sections.
3. Touch [Section] to view the enlarged screen of route section.
4. Touch [Route] to return to the previous screen.



5. Touch [Home] to return to the current vehicle map screen.

Detour

If you want to make a detour due to traffic conditions, you can use the detour function to calculate an alternative route from the vehicle location to the destination.

1. Press [MAP] > Touch [Menu] > [Route] > [Detour].
2. Touch [Shorter] or [Longer] to set a route which take a detour as the distance you select.



- Blue: Original route
- Red: Detour route

3. Touch [Start].



4. Touch the preferred route, then touch [Start].

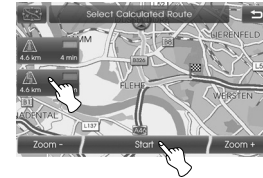

Drive in accordance with the screen and voice information.

* Note

If you don't need to take a detour when you are navigating a route, touch [Menu] > [Route] > [Detour] > [Delete].

Using the map menu

Info nearby

The list of traffic information around the current vehicle position is displayed.

1. Press [MAP] > Touch [Menu] > [Traffic] > [Info nearby].
2. Touch the desired option to check the detailed information.

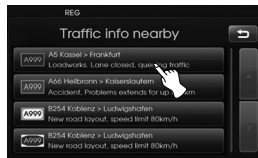

3. Touch [Show map] after checking it.



4. Touch [Zoom+] to view the map in detail. Touch [Zoom-] to view the map a wider area.



5. Touch [Back] to return to the previous screen. Press MAP to return to the current location map screen.

Info on route

The list of traffic information found on the recommended route from the current vehicle position to the destination is displayed.

A detour route to avoid the event is searched from the current vehicle position to the destination is displayed. Also, you can check the detailed information about the displayed events.

1. Press [MAP] > Touch [Menu] > [Traffic] > [Info on route].
2. Touch the desired option to check the detailed information.



3. If you need to take a detour, touch [Detour].



* Note

Touch [Show map], if you want to view the position about the event found on the route. Touch [Back] to return to the previous screen. Press MAP to return to the current location map screen.

4. Touch the preferred route.



5. Touch [Start].
Drive in accordance with the screen and voice information.

Bluetooth wireless technology

Understanding Bluetooth wireless technology

Bluetooth wireless technology establishes a wireless link between two devices, such as your phone and the unit. The first time you use two devices together you must connect them by establishing a relationship using a PIN code. After the initial connecting, the two devices can connect automatically each time you turn them on.

* Note

- There may be restrictions on using Bluetooth technology in some locations.
- Due to the variety of Bluetooth phones and their firmware version, your device may respond differently when performing over Bluetooth.
- As difference in functional operation by model is mainly resulted from feature of a hands-free phone, consult manufacturer of a phone if you have any question.
- You can check the Bluetooth phone compatibility list on the web-site (<http://www.navigation.com/hyundai>).

Connecting your unit and bluetooth phone

To connect using the unit settings (1)

1. Press  on the control panel.
2. Touch [Bluetooth].

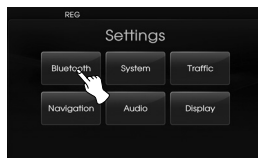

3. Touch [Search for Bluetooth devices].



If you want to cancel, touch [Cancel].

4. Touch a bluetooth phone you desire from the "Bluetooth devices" screen.



5. Input the passkey (Default: 0000) showed on the screen in your phone when the pop-up screen is displayed on the screen. When it is successfully connected, the Bluetooth main screen appears on the screen.

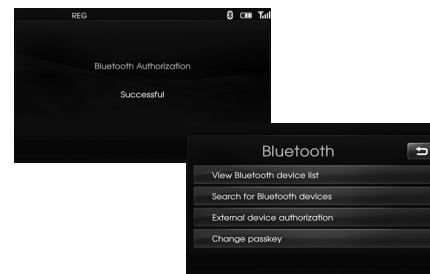

When it is not connected, the connection failure message appears on the screen.

Bluetooth wireless technology

To connect using the unit settings (2)

1. Press  on the control panel.
2. Press [Search for Bluetooth devices].

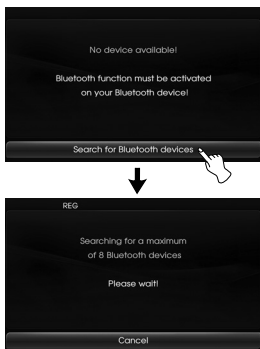

3. Follow steps 4-5 on the page 39.

* Note

If you touch  on the control panel again after connected via Bluetooth wireless technology, the Bluetooth main screen appears on the screen.

To connect using the phone settings

Your phone's Bluetooth feature may be set to off by default. To use the Bluetooth feature, Bluetooth must be turned on in your phone. Refer to your phone's user guide.

1. Enable the phone's Bluetooth component. This might be in a menu called Settings, Bluetooth, Connections, or Hands-free.
2. Press [] > Touch [Bluetooth] > [External device authorization].

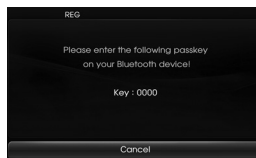

If you want to cancel, touch [Cancel].

3. Initiate a search for Bluetooth devices. These settings might be located in a menu called Bluetooth, Connections, or Hands-free.
4. Select the your device from the list of phone.

5. Input the passkey (Default: 0000) showed on the screen in your phone when the pop-up screen is displayed on the screen. When it is successfully connected, the [Bluetooth] screen appears on the screen.

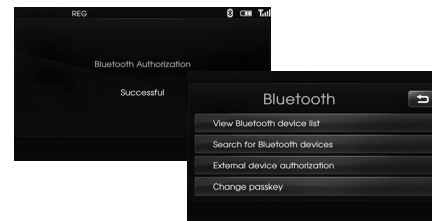

* Note

- It works the same as the wired headset for mobile phone. The headset functionality is for telephone conversation. It is not for listening to music.
- Unlike the hands-free functionality, Headset connection will allow only two functions "answering calls" and "making a call from the latest call". Also the caller's number is not displayed when answering calls.
- If connecting through a Bluetooth phone, the hands-free connection or headset connection may not operate depending on the type of the phone.

Bluetooth wireless technology

Viewing the connected bluetooth phone



1. Touch [View Bluetooth device list] on the "Bluetooth" screen.

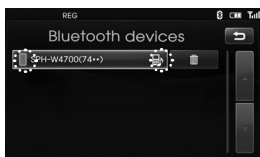

2. Check the connected phone on the "Bluetooth devices" screen.



When your phone is connected to the unit, the  mark appears on the "Bluetooth devices" screen.

When the  mark appears on the right-hand side of the connected phone list, you can use the hands-free (pages 42 - 45) function and audio streaming (page 46) function. If the  mark appears, you can only use the hands-free function (pages 42 - 45).

Disconnecting/Connecting again the bluetooth phone

1. Touch [View Bluetooth device list] on the "Bluetooth" Screen.



2. Touch the connected phone. And then touch [Yes].



Your phone is disconnected and the  mark disappears.

3. Touch the disconnected phone again to connect your phone. And then touch [Yes].

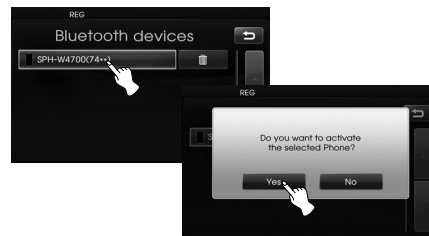

The  mark appears again.

Deleting a connected phone

If you no longer need to use a connected phone, you can delete it.

1. Touch [View Bluetooth device list] on the "Bluetooth" screen.



2. Touch  on the right-hand side of the device name of the phone you want to delete.

Bluetooth wireless technology

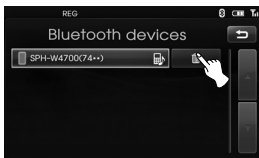

3. Touch [Yes].



- The connected phone is deleted.
- When not deleting a connected phone, touch [No].

Changing the passkey

You can change the passkey.



1. Input the passkey using the keypad and [X].
2. Touch [OK].

Making a call by entering phone number

The most basic way to make a call is to simply dial the number. Connect your unit and bluetooth phone before you make a call.

1. Press the [Phone] button on the control panel. The Bluetooth main screen appears on the screen.
2. Input the phone number you want to call by touching the number buttons. And then touch [Sound dial].



3. Touch [Hang up] to finish the telephone conversations.



* Note

- If you make a mistake while dialing, touch [C] to erase one digit at a time. If you want to erase all digits at a time, touch and hold [C].
- Touch [Phone] for long to make a call from a latest call.
- If you want to make an international telephone call, touch [0] for long, then input the phone number.
- The user's recent call history applies only to the hands-free connection. (Making a call from a recent call with the headset connection depends on the call history of the Bluetooth phone.)
- The headset connection allows only making a call from a recent call.

Switching the sound path during a call

You can hear sound through the speaker of unit and phone by touching [Transfer call]/ [Transfer call back].

Switching the microphone on/off

You can switch the microphone on/off by touching [Microphone off]/ [Microphone on].

Bluetooth wireless technology

Answering calls

1. When you receive a call, your phone rings and the "Incoming Call" pop-up screen is displayed on the screen.
2. Touch [Accept] to answer the call.

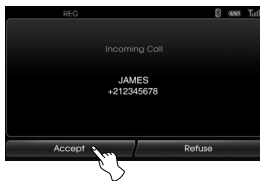

If you want to reject a call, touch [Refuse].

* Note

- If the Call-ID service is available, the caller's phone number is displayed.
- If the phone number is in the phone book, phone book entry's name is displayed.
- If the incoming call is from a number stored in your Contacts, the entry's name is displayed. The caller's phone number may also be displayed, if available.
- If "Rejecting" function is unusable, then the phone connected to the device does not support the rejecting calls function.

Using your Phone Book

You can use the phone book entries stored on the memory of phone supporting PBAP (Phone Book Access Profile) profile.

After connecting your unit and bluetooth phone via Bluetooth wireless technology, the numbers in your phone's phone book is transferred automatically into phone book.

Calling a number in the phone book



After finding the entry in the phone book you want to call, you can select the number and make a call.

1. Press  on the control panel. And then touch [Phonebook].

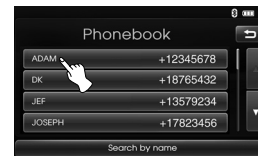

2. Touch a phone book entry you want to call.



Touching  or  switches to the next or previous page in the list.

3. Touch [Hang up] to finish the telephone conversations.

Searching the phone book entry by alphabet

If there are many entries in the phone book list, it can be useful to display them in the alphabetical order for easier searching.

1. Touch [Search by name] on the "Phone book" screen.

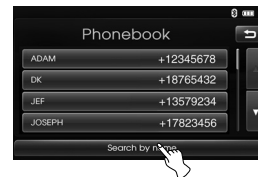

Bluetooth wireless technology

2. Input the first letter of the entry in the phone book list you want to search by using the keypad, then touch [OK].



3. Touch a phone book entry you want to call.



Touching ▲ or ▼ switches to the next or previous page in the list.

4. Touch [Hang up] to finish the telephone conversations.

Using your Calling list

You can use the calling list stored on the memory of phone supporting PBAP (Phone Book Access Profile) profile. After connecting your unit and blue-tooth phone via Bluetooth wireless technology, the numbers in your phone's [Outgoing calls], [Missed calls], and [Incoming calls] list is transferred automatically into calling list.

Calling a number in the calling list

After finding the entry you want to call in the [Outgoing calls], [Missed calls], or [Incoming calls] list, you can select the number and make a call.

1. Press on the control panel. And then touch [Calling lists].



2. Touch [Outgoing], [Missed], or [Incoming].

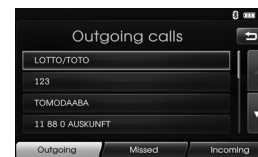

Outgoing calls

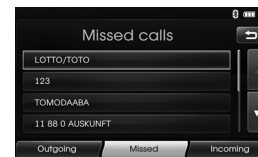

Missed calls

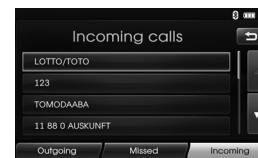

Incoming calls

3. Touch the entry you want to call.
4. Touch [Hang up] to finish the telephone conversations.

Bluetooth wireless technology

Making a call with speed dial numbers

You can use the phone book entries stored on the memory of phone supporting PBAP (Phone Book Access Profile) profile.

You can easily store up 12 phone numbers and later recall them the touch of a speed dial number.

Registering phone numbers to the speed dial list

1. Press on the control panel. And then touch [Speed dial].



2. Touch and hold one of speed dial numbers (1-12). (For example: 1)



Touching or switches to the next or previous page in the list.

3. Touch one of categories you want to assign to speed dial number. (For example: Phone book)



4. Touch one of phone numbers you want to assign to speed dial number.

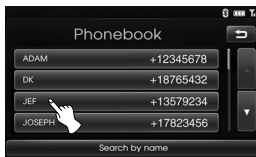

5. Input the name by using the keypad, then touch [OK].



The name (phone number) is stored in memory. The next time you touch the same name, the name (phone number) is recalled from memory.

Calling a number in the speed dial list

1. Press on the control panel. And then touch [Speed dial].
2. Touch one of speed dial numbers to make a call.



3. Touch [Hang up] to finish the telephone conversations.

* Note

Make sure that the speed dial functionality in the Bluetooth phone is enabled before using.

Bluetooth wireless technology

Activating the audio streaming mode

Connect your unit and bluetooth phone before activating the audio streaming mode. (Pages 39 - 40)

Press MEDIA repeatedly until "BT" appears on the screen.





* Note

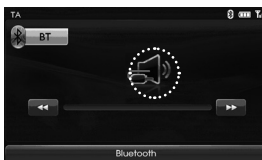

If the music information (song, artist, album) is not supported on your phone, the  mark appears on the screen.



Skip to the previous/next music

Touch / to select the previous/next music.

Search

Touch and hold the  or  buttons during playback and then release at the point you want.

* Note

- The unit may not support the audio streaming function depending on the type of the phone.
- If you disconnect your unit and bluetooth phone, the music is not played on the unit.

CD/MP3/WMA/USB/iPod operation

Playing an audio CD and MP3/ WMA/ USB/ iPod files

Disc

Insert a disc in the disc slot and playback will start automatically.

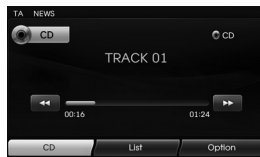

Audio CD

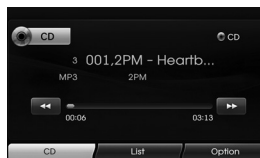

MP3/WMA CD

USB

You can play the files recorded in a USB memory device.

Connect a USB device to the USB port and playback starts automatically.



iPod

You can play an iPod device on the unit by connecting the iPod to the USB port by using the appropriate cable.

Connect an iPod device to the USB port and playback starts automatically. For details about iPod, refer to the iPod User Guide.



* Note

Use the car cable for exclusive use of iPod when connecting iPod to the terminals for iPod device for playback.

Skip to the next track/file **ALL**

Touch  to select the next track/file.

Skip to the previous track/file



ALL

Touch  within 1 second of playing time.

Return to the beginning of the current track/file **ALL**

Touch  after 1 second of playing time.

Search **ALL**

Touch and hold the  or  buttons during playback and then release at the point you want.

CD/MP3/WMA/USB/iPod operation

Intro scan **Disc - Audio CD** **USB** **Disc - MP3/WMA**

The first 10 seconds of each tracks/files are played.

1. Touch [Option] during playback.



Example: Audio CD

2. Touch [Scan start].



3. Touch [Scan stop] to cancel the intro scan.



Repeat **ALL**

The current selected tracks/files are played repeatedly.

1. Touch [Option] during playback.



Example: Audio CD

2. Touch [Repeat] repeatedly.



Disc - Audio CD

- [Repeat off] : Plays repeatedly all tracks within the disc.
- [Repeat track] : Plays repeatedly the current track.

USB **Disc - MP3/WMA**

- [Repeat off]: Plays repeatedly all files within the disc or USB.
- [Repeat track]: Plays repeatedly the current file.
- [Repeat folder]: Plays repeatedly all files within the current folder.

iPod

- [Repeat off]: Plays repeatedly all files within the iPod.
- [Repeat on]: Plays repeatedly the current file.

CD/MP3/WMA/USB/iPod operation

Random **ALL**

All of the tracks/files are played Randomly.

1. Touch [Option] during playback.

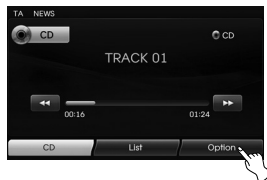

2. Touch [Random] repeatedly.



Disc - Audio CD

- [Random all]: Plays Randomly all files within the disc.
- [Random off]: Cancels Random play.

USB **Disc - MP3/WMA**

- [Random off]: Cancels Random play.
- [Random folder]: The unit plays Randomly all files within current folder.
- [Random all]: The unit plays Randomly all files within the disc or USB.

iPod

- [Random off]: Cancels Random play.
- [Random all]: The unit plays Randomly all files within the iPod.
- [Random album]: The unit plays Randomly all files within current album.

Playing files by classifying into folder/ Album/ Artist

USB

You can play files within the USB by classifying into folder, album, or artist.

1. Touch [Option] during playback.



2. Touch [Folder], [Album], or [Artist] during playback.
 - [Folder]: Plays the files by classifying into folder.
 - [Album]: Plays the files by classifying into album.
 - [Artist]: Plays the files by classifying into artist.

* Note

If you want to move to the playlist screen, touch **USB**.

CD/MP3/WMA/USB/iPod operation

Locating a folder/file using the list

Disc - Audio CD USB

Disc - MP3/WMA

You can listen to music by displaying the track/folder/file list.

1. Touch the [List] button during playback.



Example: Audio CD

2. In case of Audio CD, touch the file you want.
In case of MP3/WMA file, touch the folder button you want. If there is no folder, touch the file you want.



Audio CD

MP3/WMA file

3. The selected track/file is played.

* Note

- In case of MP3/WMA file, touch the [L] button to move to upper folder.
- Touch the ▲ or ▼ buttons to select the list you want to view.
- If you want to move to the playlist screen, touch [CD].

Searching music iPod

You can search iPod for playlist, artist names, album titles, Genre, songs, composer, audio books, podcasts. For details about iPod, refer to the iPod User Guide.

1. Touch [List] during playback.

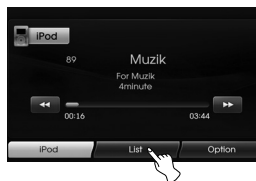

2. Touch the desired item.



- [Playlists]: Plays the songs in the [Playlists].
- [Artists]: Plays the songs in the [Artists].
- [Albums]: Plays the songs in the [Albums].
- [Genres]: Plays the songs in the [Genres].
- [Songs]: Plays the songs in the [Songs].
- [Composers]: Plays the songs in the [Composers].
- [Audiobooks]: Plays the songs/chapters in the [Audiobooks].
- [Podcasts]: Plays the songs/chapters in the [Podcasts].

* Note

- If you want to move to upper folder, touch [L].
- Touch the ▲ or ▼ buttons to select the list you want to view.
- If you want to move to the playlist screen, touch [iPod].

CD/MP3/WMA/USB/iPod operation

Setting audio book play speed **iPod**

Setting the play speed only affects audio books purchased from the iTunes store or audible.com.

For details about iPod, refer to the iPod User Guide.

1. Touch [Option] when you listen to songs/ chapters in the [Audiobook].

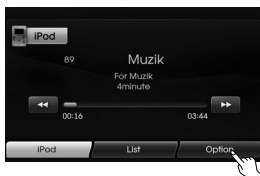

2. Touch [Audiobook] repeatedly.



- [Audiobook normal]:
Plays the audio books with original speed.

- [Audiobook fast]:
Plays the audio books with fast speed.
- [Audiobook slow]:
Plays the audio books with slow speed.

* Note

If you want to move to the playlist screen, touch **iPod**.

USB device requirement

- This unit supports only USB Flash Drive and USB External HDD with FAT16 or FAT32 format.
- Do not extract the USB device during operation (play, etc.).
- Regular back up is recommended to prevent data loss.
- If you use a USB extension cable or USB HUB, the USB device may not be recognized.
- Some USB devices may not work with this unit.
- Digital camera and mobile phone are not supported.
- This unit is not supported when the total number of files is 10000 or more.

Compatible USB devices

- Devices which require additional program installation when you have connected it to a computer, are not supported.
- MP3 player: Flash type MP3 player
The MP3 player requiring installation of a driver is not supported.
- USB Flash Drive: Devices that support USB2.0 or USB1.1 .
- You can check the USB compatibility list on the web-site (<http://www.navigation.com/hyundai>).

CD/MP3/WMA/USB/iPod operation

MP3/WMA file requirement

- Sampling Frequency / 16 - 48 kHz (MP3) 8 - 44.1 kHz (WMA)
- Bit rate / within 8 - 320 kbps (MP3) 5 -160 kbps (WMA)
- CD-R/CD-RW physical format should be "ISO 9660"
- If you record MP3/WMA files using software which cannot create a FILE SYSTEM, for example "Direct-CD" etc., it will not be possible to playback MP3/WMA files.

We recommend that you use "Easy-CD Creator" which creates an ISO9660 file system.

Customers should also note that permission is required in order to download MP3/WMA files and music from the Internet. Our company has no right to grant such permission. Permission should always be sought from the copyright owner.

iPod device requirement

- Compatibility with your iPod may vary depending on the type of your iPod.
- Depending on your iPod's software version, it may not be possible to control your iPod from this unit. We recommend installing the latest software version.
- If you have a problem with your iPod, please visit www.apple.com/support/ipod.
- This system can receive analog sound from the following iPod models.
 - iPod touch 1th generation
 - iPod mini (1st/2th generation)
 - iPod nano (1st/3th generation)
 - iPod classic (4st/5th/6th generation)
- If content on the iPod is not played back correctly, update your iPod software to the latest version. For details about updating the iPod, check the Apple web site <<http://www.apple.com>>.
- Apple is not responsible for the operation of this device or its compliance with safety and regulatory standards.

Radio operation

Listening to the radio stations

1. Press the "RADIO" button to select the radio.



2. Press the "RADIO" repeatedly to select a band. The mode switches as follows. FM → AM → FM...

*** Note**
To select the FM/AM by touching the screen, touch **FM** on the screen to select the AM and then touch **AM**.



3. **Auto tuning:** Touch **◀/▶** on the screen. Or press **▲/▼** on the control panel.
 - When a station is received, searching stops.**Manual tuning:** Rotate the Jog dial leftward/ rightward on the control panel.
 - The frequencies move up and down step by step.

Storing and recalling stations

You can easily store up to 12 preset stations for later recall at the touch of a button.

1. Select the band (FM, AM) you want to store a station into.
2. Select the desired frequency.
3. Touch [Presets] on the screen.



4. Touch and hold one of the preset buttons. The preset station information will be displayed. The selected preset station has been stored in memory.



If you move to the previous/next page, touch **◀/▶**.

5. Repeat steps 1 and 4 to preset other stations. Next time, if you touch the preset buttons, the station is recalled from the memory.

*** Note**
When a station is preset on the preset station button number on which another station of the same band has already been preset, the previously preset station is automatically erased.

Radio operation

AS (Autostore)

This is only available for AM reception. This function lets you automatically store the strong broadcast frequencies.

1. Select the band to AM.
2. Touch [Option] on the screen.
3. Touch [Autostore] on the screen.



Local stations with the strong signals are searched and stored automatically in the list menu. And then the list menu appears on the screen.



4. Touch the broadcast frequency you want.

To scan broadcast frequencies

The first 10 seconds of each broadcast frequency are played.

1. Touch [Option] on the screen in AM/FM mode.



2. Touch [Scan start] on the screen.
3. Touch [Scan stop] to cancel it.

TA (Traffic announcement)

TA function allows the unit to switch to traffic announcement (TA) from the current source (Another FM station, CD, or other connected components).

1. Touch [Option] on the screen in AM/FM mode.
2. Touch [TA off]/ [TA on] on the screen.



[TA on]: Traffic programs and announcements can be automatically received using TP/TA features.

[TA off]: Traffic programs and announcements can not be received.

Radio operation

NEWS

This function allows the unit to switch to news from the current source (Another FM station, CD, or other connected components).

1. Touch [Option] on the screen in AM/FM mode.
2. Touch [News off]/ [News on] on the screen.



[News on]: News can be automatically received.

[News off]: News can not be received.

Region auto/Off

This is only available for FM reception.

1. Select the band to FM.
2. Touch [Option] on the screen.
3. Touch [Region auto]/ [Region off] on the screen.



[Region auto]:

The unit switches to another station, within the same network, broadcasting the same program when the receiving signals from the current station become weak.

[Region off]:

The unit switches to another station, within the same network when the receiving signals from the current station become weak. (This mode, the program may differ from the one currently received.)

Auxiliary device operation

Using an AUX source

It is possible to use auxiliary equipment with unit.

1. Press "MEDIA" until "AUX" screen appears.

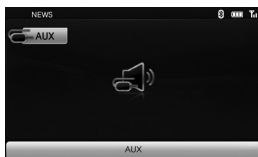

AUX Audio



AUX Video

2. Connect an auxiliary device to the AUX connector, then activate the auxiliary function.

* Note

- Some auxiliary devices that don't have the video source may not output the video screen.
- In case of some iPod devices, Use the iPod cable for exclusive use of iPod for video playback when connecting iPod to the AUX connector.
- Video is not available while driving. (Based on the traffic regulation, Aux Video is only available whenever vehicle is in stop condition with parking brake.)

Adjusting the video screen (Default : Center)

For safety reasons, the video screen cannot be viewed while your vehicle is in motion. To view video screen, you must stop in a safe place and put on the handbrake.

1. Touch the screen on the aux video mode.
2. Touch "AUX" on the screen.
3. Select the item you want to adjust.

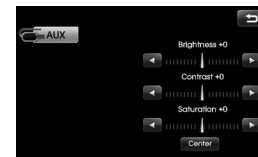

- Brightness: Touch ◀ or ▶ to adjust the brightness of screen.
- Contrast: Touch ◀ or ▶ to adjust the contrast of screen.
- Saturation: Touch ◀ or ▶ to adjust the saturation of screen.

* Note

Touch [Center] to return to the default settings.

Voice recognition system

Voice recognition

Voice recognition allows hands-free operation of the AV system (RADIO, CD, USB, iPod), navigation and other systems equipped on this vehicle, such as the phone.

* Note

To get the best recognition performance out of voice recognition, observe the following:





- Keep the interior of the vehicle as quiet as possible. Close the windows to eliminate the surrounding noises (traffic noises, vibration sounds, etc.), which may prevent the system from recognizing the voice commands correctly.
- Wait until a beep sounds before speaking a command. Otherwise, the command will not be recognized properly.
- Speak in a natural voice without pausing between words.
- The supporting languages in Voice recognition system are English, German, French, Spanish and Italian at this moment.

Giving voice commands

1. Press  on the steering wheel remote control.
2. After the beep sounds, say "Help". All commands shall be listed which are presented in active fields.



* Note

- If the command is not recognized, the system announces, 1st time "Pardon?", 2nd time "Please, repeat", and 3rd time "Command is not recognized".
- If you want to cancel the voice recognition, press  one more time or press the any button or touch screen say "Cancel".
- If you want to adjust the volume of the system feedback, press + or - on the steering wheel remote control or use the volume knob () on the control while the voice recognition is active.

How to say numbers

Voice recognition requires a certain way to say numbers in voice commands. Refer to the following examples. (General rule: Either "zero" or "oh" can be used for "0")

Frequency

Say frequency number according to the following example.

"Frequency ninety five comma four"/ "Ninety five comma four mega-hertz"



Phone number

Say phone number according to the following example.

0-1-0-2-0-0-5-2 (Single digit)

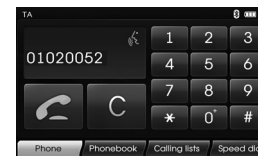

Voice recognition system

Voice command examples

To use the voice recognition function, saying one command is sometimes sufficient, but at other times it is necessary to say two or more commands. As examples, some additional basic operations by voice commands are described here.

Example 1: Changing FM Radio & Frequency

1. Press  on the steering wheel remote control.
2. After the beep sounds and say "FM".
3. When the "FM" command recognized, the main screen will be changed to the FM main screen.



4. Press  on the steering wheel remote control.

5. After the beep sounds and say "Frequency one-hundred two" or "one-hundred two mega hertz".
6. When the spoken frequency is recognized, the FM frequency is changed to the 102 MHz.



Example 2: Changing playlist of USB (CD)



1. Press  on the steering wheel remote control.
2. After the beep sounds and say "List".
3. When the command recognized, the screen will be changed to the USB (CD) LIST screen.

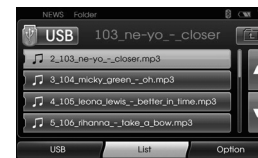

4. Press , after the beep sounds, you can say one of the playlist like a "micky green oh".
5. When the playlist is recognized, it is played at once.



6. Press , on the steering wheel remote control.
7. After the beep sounds and say "Next track" or "Previous track".
8. When the command is recognized, the played list is changed to "Next track" or "Previous track".

Voice recognition system

Example 3: Dial number

To use this function, you need a mobile phone which is supported a Bluetooth. Connect your unit and bluetooth phone before using.

1. Press  on the steering wheel remote control.
2. After the beep sounds and say "Dial Number".
3. When the spoken command is recognized, the screen is changed to the bluetooth main screen, and then the system announces "Please say the phone number".



4. Say the phone number like "01020052" (single digit).

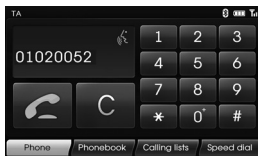

5. When the spoken numbers are recognized, the system announces the recognized numbers and then a prompt "and then?".
6. If you want to make a call the recognized number, say "Call".
If there is unrecognized number or you want to delete the number, say "Clear".
If you want to finish it at any time, say "Cancel".

Help command

If you are controlling the system by voice commands for the first time or do not know the appropriate voice command, say the following command.

1. Press  on the steering wheel remote control.
2. After the beep sounds, say "Help".
All commands shall be listed which are presented in active fields.



3. The voice feedback will announce "Possible commands are".
4. After the beep sounds, say "Other commands".
Application commands shall be listed which are presented in active fields.



5. The voice feedback will announce "Possible commands are".
6. After the beep sounds, say "AUX".
The screen is changed to the AUX screen.



Voice recognition system

Voice commands

Category	Voice command
Application command	AUX
	CD
	iPod
	Map
	Radio
	USB
	Bluetooth
	Phone
	Media

Category	Voice command
General functions	Volume down
	Volume up
	Previous page
	Next page
	Help
	Other commands
	Cancel
	No
	Yes

Category	Voice command
Radio	News off
	News on
	Next station
	Previous station
	TA off
	TA on
	Preset <number>
	Presets
	AM
	FM
	List
	Option
	Scan start
	Scan stop
	Frequency "x" comma "yy"
	Frequency "xxxx"
	Autostore
	Region auto
	Region off

Category	Voice command
Phone	Dial Number
	Incoming
	Missed
	Outgoing
	Phone Book
	Call Name
	Speed Dial <number>
	Call
	Calling lists
	Speed dial
	Mobile
	Private
	Office
	Clear
	Correction

Category	Voice command
Bluetooth media (A2DP)	Next track
	Previous track

Voice recognition system

Voice commands

Category	Voice command
iPod	Repeat off
	Repeat on
	Scan start
	Scan stop
	Random off
	Random all
	Random album
	Audiobook slow
	Audiobook normal
	Audiobook fast
	Directory up
	List
	Option
	Next Track
	Previous Track
	Track Info
	<Folder>
Track <Number>	
OK	

Category	Voice command
MP3 (CD, USB)	Directory up
	List
	Option
	Repeat folder
	Repeat off
	Repeat track
	Scan start
	Scan stop
	Random all
	Random folder
	Random album
	Random artist
	Random off
	Track info
	Next track
	Previous Track
	<Folder>
Track <Number>	
Album	
Artist	
Folder	
OK	

Category	Voice command
Audio CD	List
	Option
	Repeat off
	Repeat track
	Scan start
	Scan stop
	Random all
	Random off
	Track info
	Next track
Previous track	
Track <Number>	
OK	
Category	Voice command
Navigation	Navigation

Troubleshooting

Cannot identify the current location. (GPS not receiving)

GPS cannot be used indoors and must be connected to a power source with ACC in a vehicle in a location where the signal from the sky can be received easily.

When initially connecting the GPS, it usually takes about 10 minutes to be working normally, but the connection speed can differ depending on the weather condition, and surrounding obstacles.

If the GPS connection is unstable for a long period of time, try the following.

- Check if the product is connected to a power source.
- Check if the back of the GPS product is in a location where the sky can be seen well.
- If there are high buildings or if you are under a tree, move to a location where there aren't any obstacles.

Cannot hear the voice guide.

The volume is not set correctly, or it is turned off. Adjust the volume of voice guidance.

There is a difference between the driving road and the road on the map in the product.

Even though GPS is usually very accurate, there is a small margin for error. When the GPS receiver is installed, there can be an error of about 10m. But for newly built roads, the problem could come from the data update to the map.

Cannot see the map.

Perhaps you cannot see the map even when you have executed the navigation menu.

This happens when the data within the memory is damaged. Delete all the data in the memory and install the data again. If the issue persists after installation, contact the A/S center.

The path guide can be different from the actual path. (Path guide error)

- When the road is closely parallel.
- When the splitting road angle is very small.
- When there is an adjacent road when turning.
- When driving on a road that is narrow-driving fast.

- When driving through the mountain or where the road is too curvy.
- When the starting, passing and arriving locations are too close within 1km.
- When you have set the starting, passing or arriving location more than 1km away from the road.
- When driving through the tunnel.

Map matching

As mentioned, the GPS systems used by this Navigation System are susceptible to certain errors. Their calculations may on occasion place you in a location the map where no road exists. In this situation, the processing system understands that vehicles travel only on roads, and is able to correct your position by adjusting it to a nearby road. This is called map matching.

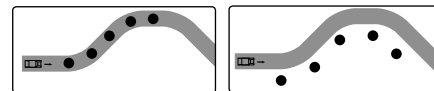

With map matching.

With no map matching.

How to update the navigation map and software

To update the navigation map and software, visit the site (<http://www.navigation.com/hyundai>).

Troubleshooting













Symptom	Cause	Correction
Power doesn't turn on. The unit doesn't operate.	The ignition switch is NOT turned ON.	Turn the ignition switch to ON.
	The ignition switch is NOT set to ACC.	Set the ignition switch to ACC.
	The power of unit is turned OFF.	Turn the unit on by pressing  on the control panel.
	Noise and other factors are causing the built-in microprocessor to operate incorrectly.	Turn the unit off and then on.
Playback is not possible.	The disc is dirty.	Clean disc.
	The loaded disc is a type this unit cannot play.	Check what type the disc is.
	The disc is inserted upside down.	Insert the disc with the label upward.
	The files on the disc are an irregular file format.	Check the file format.
There's no sound.	The volume level is low.	Adjust the volume.
	The mute is on.	Turn the mute off.

Index

Address book.....	24	Parking.....	28
Address Search.....	23	Phone number.....	26
Answering calls.....	43	POI category.....	34
AS (Autostore).....	54	POI (Point of Interest).....	24
Bluetooth wireless technology.....	39	Random.....	49
Changing the passkey.....	42	Region auto/Off.....	55
Detour.....	37	Repeat.....	48
Giving voice commands.....	57	Return to the beginning of the current track/file.....	47
GPS input.....	27	Route options.....	36
Help command.....	59	Search.....	47
Home 1/ Work 2/ 3 ~ 12.....	32	Setup.....	16-19
In City.....	26	Skip to the next track/file.....	47
Info nearby.....	38	Skip to the previous track/file.....	47
Info on route.....	38	Split screen/ Full screen.....	35
Intro scan.....	48	Store destination.....	31
Hyundai service.....	26	Store position.....	31,35
Last destinations.....	24	Switching the microphone on/off.....	42
Making a call by entering phone number.....	42	Switching the sound path during a call.....	42
Making a call with speed dial numbers.....	45	TA (Traffic announcement).....	54
Near destination.....	26	Tour planner.....	29-30, 35
Near position.....	25	2D/ 3D.....	34
NEWS.....	55	Using map.....	28
		Using your Phone Book.....	43-44
		Using your Calling list.....	44
		Voice commands.....	60-61
		Voice recognition.....	57

Symbols for the display of traffic problems

If the traffic problem is on the calculated route, the symbol will be highlighted.

Symbol	Description	Symbol	Description
	Rock fall		Stationary traffic
	Accident		Queuing traffic
	Other danger		Wind Storm
	Road narrow		Snow, Ice
	Chipping		Block road, Closed
	Road work		Emergency phone not work
	Slippery road, Rain		

Support - Hotline

Web Site : <http://www.navigation.com/hyundai>

International Toll Free Number: 00800 18 23 53 22

Telephone number for
all other countries
(or if Toll Free numbers
are not supported) : +31 555 384 245



P/N: MFL62880534